

HP Archive

This vintage Hewlett Packard document was
preserved and distributed by

[www. hparchive.com](http://www.hparchive.com)

Please visit us on the web !

Scanned by on-line curator: Tony Gerbic

**** For FREE Distribution Only *****

HEWLETT-PACKARD
CORPORATION
AVENUE
PACIFIC
HEWLETT
PACARD
CORPORATION
AVENUE
PACIFIC

500B

ELECTRONIC FREQUENCY
METER

500C

ELECTRONIC TACHOMETER
INDICATOR

SERIALS PREFIXED: 015-

OPERATING AND SERVICING MANUAL



OPERATING AND SERVICING MANUAL



**MODEL 500B
ELECTRONIC FREQUENCY METER**

**MODEL 500C
ELECTRONIC TACHOMETER INDICATOR**

SERIALS PREFIXED: 015 -



MP-S-769

SPECIFICATIONS

MODEL 500B

- FREQUENCY RANGE:** 3 cps to 100 kc. Nine ranges with full scale values of 10, 30, 100 and 300 cps; 1, 3, 10, 30 and 100 kc.
- EXPANDED SCALE:** Allows any 10% or 30% portion of a selected range to be expanded to full meter scale. (Not present on lowest range.)
- INPUT VOLTAGE:** Sensitivity: 0.2 volt rms minimum for sine waves. 1.0 volt minimum for positive pulses.
- Maximum: 250 volts peak. Sensitivity control on front panel to reduce threshold sensitivity.
- INPUT IMPEDANCE:** Approximately 1 megohm shunted by 40 pf.
- ACCURACY:** Unexpanded scale, better than $\pm 2\%$ full scale value of range selector setting. Line voltage variations of nominal $\pm 10\%$ affect reading less than $\pm 1/2\%$.
- Expanded X3 scale, (differential measurements of 30% or less), better than $\pm 1-1/2\%$ of range switch setting. Line voltage variations of $\pm 10\%$ affect reading less than $\pm 1/2\%$.
- Expanded X10 scale, (differential measurements of 10% or less), better than $\pm 3/4\%$ of range switch setting. Line voltage variations of $\pm 10\%$ affect reading less than $\pm 1/4\%$.
- OUTPUT LINEARITY:** (Relation of input frequency to output current at the external meter jack.) On 100 kc range: within approximately $\pm 1/4\%$ of full-scale value. On all other ranges: within approximately $\pm 1/10\%$ of full-scale value.
- SELF CHECK:** Allows calibration of internal constant current source and check against 60 cps line frequency.
- RECORDER OUTPUT:** Phone jack on panel for direct connection to 1 ma 1400 ohm ± 100 ohm recorder or to a resistance voltage divider to operate other current or voltage sensitive recorders.
- PULSE OUTPUT:** To trigger stroboscope, etc., in synchronism with input signal, to measure fm, etc.

SPECIFICATIONS (CONT'D.)

MODEL 500B (Cont'd.)

PHOTOCELL INPUT: Phone jack on panel provides bias for Type 1P41 Phototube. Allows direct connection of $\text{\textcircled{hp}}$ 506A Optical Tachometer.

POWER: 115/230 volts $\pm 10\%$, 50/1000 cps, approximately 110 watts.

DIMENSIONS: Cabinet Mount: 7-1/2" wide, 11-1/2" high, 14-1/4" deep.
Rack Mount: 19" wide, 7" high, 13" deep behind panel.

WEIGHT: Cabinet Mount: Net 17 lbs., shipping weight 22 lbs.
Rack Mount: Net 20 lbs., shipping weight 32 lbs.

ACCESSORIES FURNISHED: $\text{\textcircled{hp}}$ AC-16D Cable Assembly, 44 inches of RG-58/U 50 ohm coaxial cable terminated at one end only with a UG-88/U Type BNC male connector.

ACCESSORIES AVAILABLE: $\text{\textcircled{hp}}$ Model 508 Tachometer Generators.
 $\text{\textcircled{hp}}$ Model 506A Optical Tachometer.
 $\text{\textcircled{hp}}$ Model 500B-95A Accessory Meter (operates from recorder jack).

MODEL 500C

Specifications, circuit and construction
same as $\text{\textcircled{hp}}$ Model 500B, except for meter calibration.

SPEED RANGE: 180 rpm (with non-multiplying transducer) to 6,000,000 rpm.
Nine ranges with full scale values of 600, 2,000, 6,000, 20,000, 60,000, 200,000, 600,000, 2,000,000 and 6,000,000 rpm.

ACCESSORIES AVAILABLE: $\text{\textcircled{hp}}$ Model 500C-95A Accessory Meter (operates from recorder jack).

CONTENTS

	Page
SECTION I	GENERAL
1 - 1	General Description I - 1
1 - 2	Damage in Transit I - 2
1 - 3	Power Transformer Conversion I - 2
1 - 4	RPM Measurement with Tachometer Generators I - 2
1 - 5	Accessory Tachometer Generators I - 2
1 - 6	Photoelectric Tachometry I - 3
SECTION IIA	GENERAL
2A - 1	General II - 1
SECTION IIB	500B OPERATING INSTRUCTIONS
2B - 1	Controls and Terminals II - 1
2B - 2	Operating Procedure, Counting II - 1
2B - 3	Expanded Scale, General II - 2
2B - 4	Example Procedure II - 3
2B - 4A	Example Summary II - 3
2B - 5	Additional Scale Calibration Methods II - 3
2B - 6	Accuracy of Measurements II - 3
2B - 7	Random Counting, General II - 5
2B - 7A	Meter Time Constant II - 5
2B - 7B	Basic Accuracy II - 5
2B - 7C	Predictable Error II - 5
2B - 8	Random Counting Procedure II - 6
2B - 9	Operating Calibration and Check II - 6
2B - 10	Recorder Operation II - 7
2B - 11	Recorder Jack Response II - 7
2B - 12	Pulse Output Response II - 7
2B - 13	Pulse Output Applications II - 8
2B - 14	Measuring Klystron Incidental FM II - 9
2B - 15	Measuring Set-Ups II - 10
SECTION IIC	500C OPERATING INSTRUCTIONS
2C - 1	Controls and Terminals II - 11
2C - 2	Operating Procedure, Counting II - 13
2C - 3	Expanded Scale, General II - 13
2C - 4	Example Procedure II - 15
2C - 4A	Example Summary II - 15
SECTION III	THEORY OF OPERATION
3 - 1	Introductory III - 1
3 - 2	Input Amplifier III - 1
3 - 3	Schmitt Trigger, V2 III - 1
3 - 4	Switching Multivibrator, V4 III - 2
3 - 5	Switching Control Circuit III - 2
3 - 6	Expanded Scale III - 2
3 - 7	Calibration III - 2
SECTION IV	MAINTENANCE
4 - 1	Introductory IV - 1
4 - 2	Cabinet Removal IV - 1
4 - 3	Equipment Required IV - 1
4 - 4	Tube Replacement IV - 1
4 - 5	Trouble Localization IV - 1
4 - 6	Power Supply IV - 2
4 - 7	Trouble Shooting Chart IV - 3
4 - 8	Meter Zero Adjustment IV - 6
4 - 9	Adjusting Schmitt Trigger Sensitivity IV - 6
4 - 10	Adjusting Phantastrons IV - 6
4 - 11	Meter Shunt Adjustments IV - 6

SECTION I GENERAL DESCRIPTION

1-1 GENERAL DESCRIPTION

The Model 500B directly measures the frequency of an alternating voltage from 3 cps to 100 KC. It is suitable for laboratory measurement or production testing of audio and supersonic frequencies or for direct tachometry measurement with appropriate transducers, such as the -hp- 506A Optical Tachometer Pickup or the -hp- Model 508A/B Tachometer Generators.

The indications of the meter are independent of input waveform, permitting the instrument to count sine-waves, square waves, or pulses and to indicate the average frequency of random events. A RECORDER jack permits operation of a 1 ma recorder, such as the Esterline-Angus Automatic Recorder, for continuous frequency record. The impedance characteristics of this terminal may be adjusted to match any 1400 ohm (± 100 ohm) 1 ma recorder to the 500B meter circuit. The RECORDER jack also may be employed to drive a remote indicating meter available from the Hewlett-Packard Company as an accessory.

Besides indicating an applied frequency and providing a recorder output, however, the Model 500B is designed to be valuable in two other types of measurements. First, it is designed to be able to expand its scale readings by factors of 3 or 10 times, an arrangement that facilitates measurements of frequency changes such as might be caused by line voltage changes on frequency-generating circuits. Second, the instrument is designed to provide an output voltage which is proportional to the applied frequency. This signal from the PULSE terminal enables the instrument to be used as a wide band discriminator in applications where the measured signal contains very rapid frequency changes or frequency modulation. The discriminator voltage, when filtered, can be used to measure the amount of deviation in the signal as well as the rate and components of deviation.

The Model 500C Electronic Tachometer Indicator is similar in circuitry to the 500B except for the meter calibration. The Model 500C is calibrated in terms of RPM with a counting range from 180 RPM to 6,000,000 RPM. In conjunction with the Hewlett-Packard Model 508B Tachometer Generator the 500C will measure speeds from 15 to 40,000 RPM. When used with the Model 506A Optical Tach-

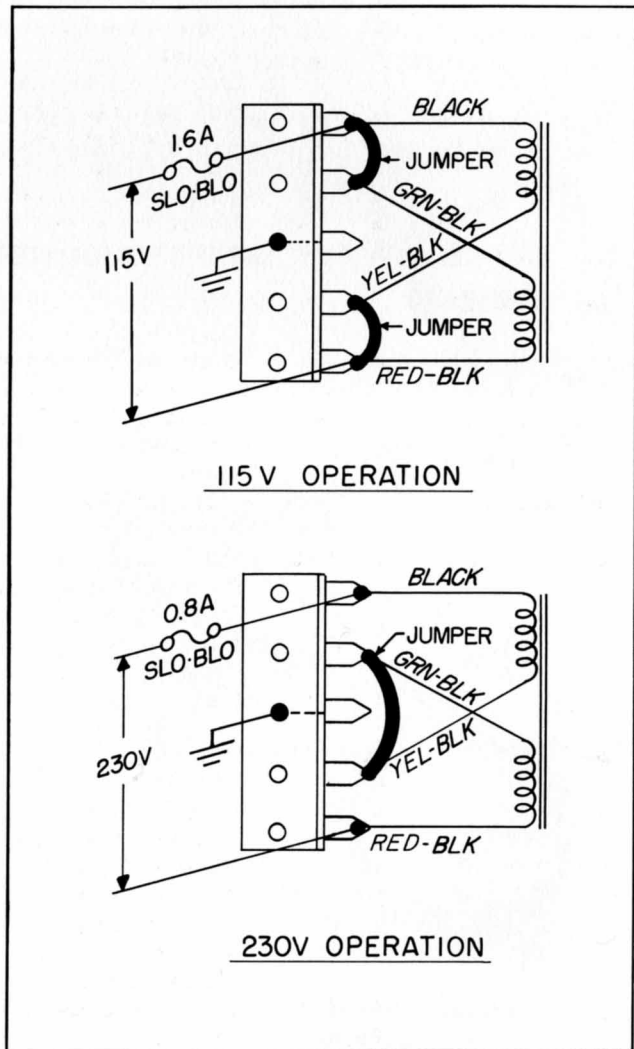

Figure 1-1. Jumper Connections. Power Transformer Primary

ometer Pickup the instrument is capable of measuring very high speeds of moving parts which have small energy, or which for mechanical reasons cannot tolerate mechanical loading.

1-2 DAMAGE IN TRANSIT

Instructions and information concerning shipping damage are contained in the WARRANTY section on the last page of this manual.

1-3 POWER TRANSFORMER CONVERSION

The Model 500B may be easily converted to operate from a 230-volt line source by removing the bare wire jumpers from the terminal strip, located beneath the power transformer, and inserting a new jumper as shown in Figure 1-2.

As shown in the schematic diagram the 230V connection changes the primary winding arrangement from parallel (115V) to series (230V).

After converting the instrument to 230 volt operation, change the line fuse, as shown, to 0.8 amperes, slo-blo.

1-4 RPM MEASUREMENT WITH TACHOMETER GENERATORS

The Model 500B measures RPM and RPS by meas-

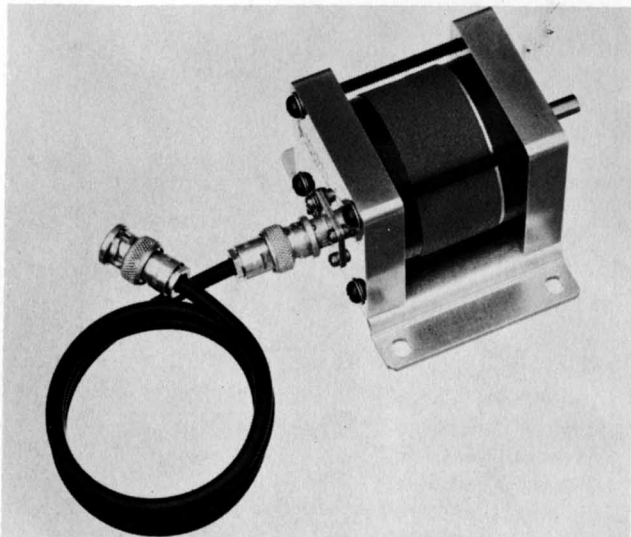

Figure 1-2. -hp- Model 508A/B Tachometer Generators

uring an electrical frequency that is proportional to the speed of a rotating shaft. Generation of this frequency may be accomplished by several types of transducers which allow considerable latitude in measurement technique.

A simple and direct way to measure RPM is through the use of a tachometer generator that produces a frequency that is proportional to the speed of its own shaft. The -hp- Models 508A and 508B are examples of this type of transducer, and are recommended for use with the Model 500B. Both are of the variable reluctance type and have no brushes or slip rings to cause noise or random irregularities that result in inaccurate readings. Other types of generators may be used if they have an output frequency proportional to their shaft speeds and are free of electrical noise and transients. (Limiting case: $S/N = 1$.) To assure accurate counts, the use of an oscilloscope to check the signal from other types of tachometer generators is recommended.

1-5 ACCESSORY TACHOMETER GENERATORS

The -hp- Models 508A and 508B are compact low-torque tachometer generators. The Model 508A produces 60 λ for each revolution of its drive shaft, while the Model 508B produces 100 λ for each shaft revolution. When using the 508A the Model 500B indicates shaft speed directly in RPM. When using the 508B, the displayed answer is divided by 100 to obtain revolutions/sec. When using the 508B, the Model 500C indicates RPM directly when divided by 100.

The useful shaft speed range for Model 508A Tachometer Generator is from approximately 15 RPM to 40,000 RPM. Consequently, this tachometer generator is entirely suitable for all shaft speeds normally encountered. The output voltage from these transducers increases almost linearly from 15 RPM to 5000 RPM from a minimum of about 0.1 volt RMS to a maximum of almost 10 volts. At shaft speeds above 5000 RPM, the output voltage decreases gradually to a value of about 1 volt at 40,000 RPM. The linear relationship between output voltage and shaft RPM to about 5000 RPM provides a very useful auxiliary function for the tachometer generator. The speed-voltage relationship makes it possible to present on an oscilloscope screen a curve describing the instantaneous rate of rotation of a shaft as a function of time. This allows analysis of the instantaneous effect on

rotating equipment from the action of clutches, brakes, or other mechanical components.

For this application, connect the output of the tachometer generator to the vertical deflection plates of an oscilloscope. Since the data presented on the oscilloscope screen is usually nonrepetitive in nature, a photographic record is normally made. Torsional vibration, harmonic-ringing and the action of intermittent motions are shown as a function of time by variations in the height of the oscilloscope trace.

1-6 PHOTOELECTRIC TACHOMETRY

Photoelectric tachometry pickups have three particular advantages: they are effective over a wide range of speeds; they are easily adaptable to a wide range of situations; they do not load a system under measurement. The Model 500B is designed for use with photoelectric transducers and a special connector (PHOTOTUBE), located on the front panel of the instrument, supplies the necessary bias voltage to a photocell of type 1P41 or equal. This jack serves also as the signal input jack for this application.

The Model 506A Tachometer provides for counting speeds or revolutions over a wide range from about 300 RPM (5 RPS) to 300,000 RPM (5,000 RPS). The light source in the Model 506A Tachometer Pickup illuminates a moving part which is prepared with alternate reflecting and absorbing surfaces. The interrupted reflected light is picked up by the phototube and the electrical impulses generated are transmitted to the 500B. This system is positive in action and the danger of fractional or multiple errors inherent in other measuring methods is eliminated.

For best results, the size of the reflecting and absorbing surfaces should be approximately 3/4 in. square. This means that the shaft whose speed is to be measured should have a diameter of at least 1/2 inch. The speeds of smaller diameter shafts may be measured by installing a sleeve of larger diameter, or by providing a rotating, reflecting, and absorbing surface at right angles to the plane of the shaft. Surfaces such as these are also used for increasing resolution in measurement of low RPM where the multiple absorbing and reflecting surfaces provide a large number of impulses per revolution. When this is done, a division factor

is applied to the reading obtained on the Model 500B.



Figure 1-3. -hp- Model 506A Optical Tachometer Pickup

The -hp- Model 506A consists of a pair of shielded tubes, one of which contains an incandescent light source, while the other houses a Type 1P41 Phototube. These are equipped with condensing lenses and are so oriented that proper focus is obtained at a distance between 3 and 6 inches from the reflecting surface. The light source and phototube assembly is mounted on an adjustable stand for optimum positioning of both light source and phototube. The base of this stand contains a transformer which provides the proper voltage for operating the incandescent lamp. The phototube requires a bias voltage from +70 to +90 volts. This voltage is automatically supplied by the PHOTOTUBE jack on the -hp- Model 500B.

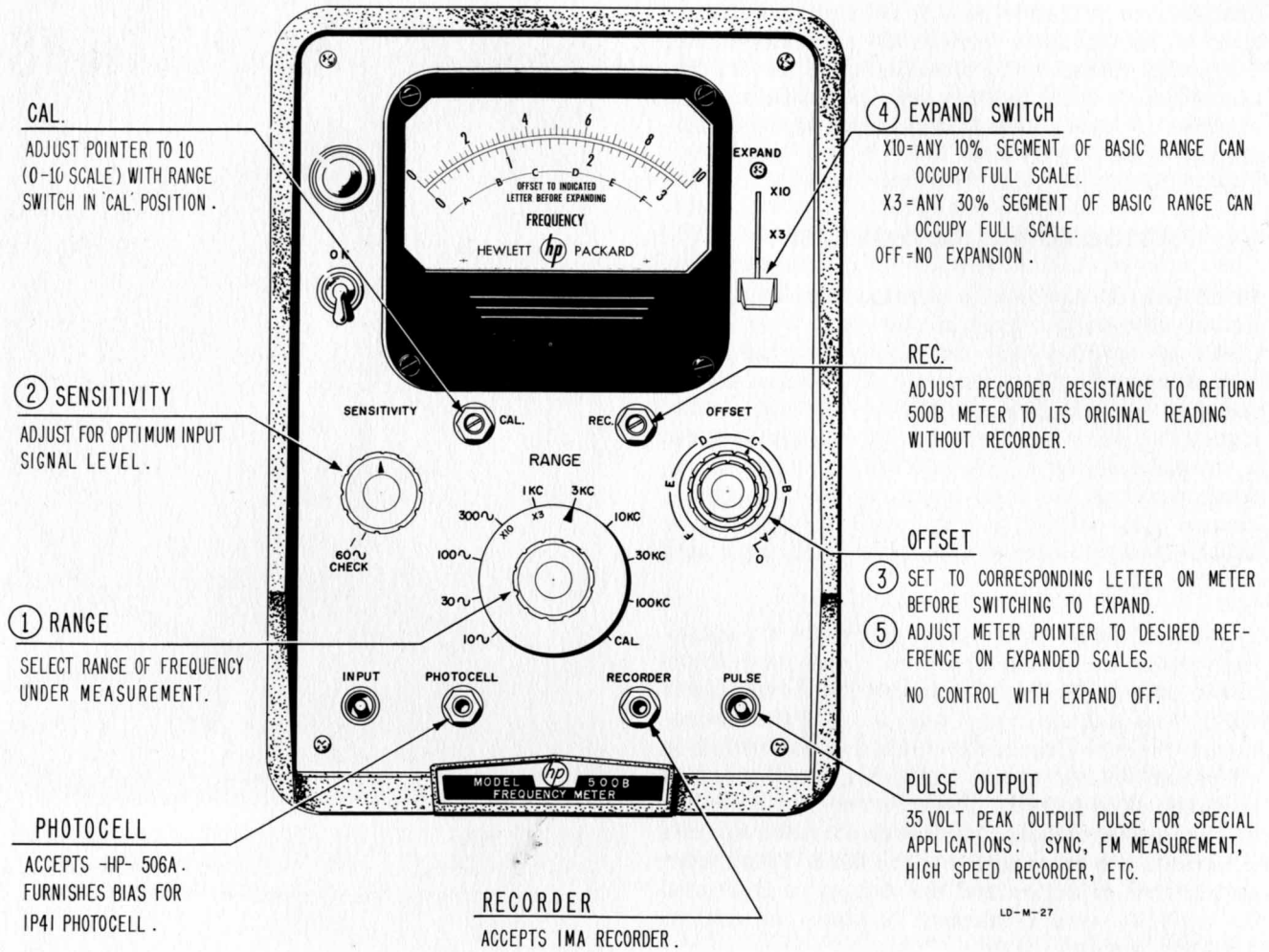

Figure 2B-1. Front View Describing Operating Controls

SECTION II

OPERATING INSTRUCTIONS

SECTION IIA

2A-1 GENERAL

The operating instructions for the 500B and the 500C are given in two separate sections. The 500B is covered in Section IIB and the 500C is covered in Section IIC. The instruments are identical electrically. The only difference is the meter face calibration and the range selector markings. The paragraphs in the 500B which cover accuracy of measurements, random counting procedure, recorder operation, and pulse applications, are not repeated in Section IIC, although they apply equally well to the 500C.

SECTION IIB

500B OPERATING INSTRUCTIONS

2B-1 CONTROLS AND TERMINALS

SENSITIVITY

This control, normally in the maximum position, is used to decrease the sensitivity of the input amplifier to eliminate errors resulting from spurious modulation of the desired signal.

60 \sqrt CHECK

This switch position on the SENSITIVITY control places the line frequency into the input circuit. With the RANGE switch in the appropriate position (usually 100 \sqrt) and the EXPAND switch OFF, the meter should indicate the frequency of the line voltage.

RANGE

This rotary switch selects the desired frequency range.

CAL

The CAL position of the RANGE switch checks satisfactory calibration of the constant current source in the circuit by indicating full scale on the 0-10 scale. In this position, input signals have no effect upon the meter.

CAL ADJUST

This screwdriver adjustment is used to calibrate the constant current source. See paragraph 2-9.

EXPAND

Expands any 10 percent (X10) or any 30 percent (X3) of the basic range in use to full scale. Use of the expanded scale is discussed in paragraph 2B-3.

INPUT

This BNC connector accepts any unknown signal from 0.2 to 150 volts rms.

PULSE

This BNC connector is an output terminal providing 35 volt peak pulse out for special applications (see paragraphs 2B-12, 2B-13).

PHOTOTUBE

This phone-type jack furnishes bias for a 1P41 phototube permitting the direct connection of the -hp- Model 506A Optical Tachometer.

RECORDER

This phone-type jack is provided for connecting a 1 ma recorder to the instrument.

REC ADJ

This screwdriver-operated potentiometer adjusts the effective resistance of a recorder to match the instrument. The adjustment procedure is described in paragraph 2B-9.

2B-2 OPERATING PROCEDURE, COUNTING

- a. Allow a period of five minutes for the instrument to reach a stable operating temperature after turning ON.
- b. Turn the SENSITIVITY control to the maximum clockwise position. Place the EXPAND switch to OFF.
- c. Set the RANGE switch to the 100 KC position.

d. Place signal under test across the INPUT connector.

e. Step the RANGE switch down from the 100 KC position as necessary until the meter pointer rests in the top 2/3 of the meter scale. Decrease the SENSITIVITY control and watch for a change in the reading. The reading should remain constant over a plateau of control to assure you that noise modulation is not being measured as part of the signal under test.

It is necessary with unknown input frequencies to start the RANGE switch at 100 KC and step down, because inputs in excess of values on RANGE switch can overdrive the instrument to display erroneous readings, i.e.: 2 KC will be erroneously displayed on the 1 KC range, but not on 3 KC range and above.

2B-3 EXPANDED SCALE, GENERAL

The expanded scale feature allows increased accuracy in the measurement of changes in frequency by magnifying pointer action. The pointer action is magnified by expanding to full scale a 30 percent segment (X3 setting of the EXPAND switch) or a 10 percent segment (X10 setting of the EXPAND switch) of the range selected by the RANGE switch. The particular expanded segment represented by the meter scale is determined by the concentric OFFSET controls, which move the segment between zero and full scale of the basic range. Since the segment selection is arbitrary and the meter pointer always indicates the value of the input signal, the meter pointer will be on scale only if the selected segment includes the frequency of the input signal. The number of cycles in the segment is indicated by the X3 or X10 on the skirt of the RANGE switch (see Figure 2B-2).

A letter system helps find the segment which includes the input signal; the letters are marked both on the meter face and around the OFFSET controls. When an unexpanded measurement is made, the meter pointer indicates a point on the letter system as well as the value of the input signal, and the coarse OFFSET control should be set near that point of the letter system before the EXPAND switch is actuated. When the EXPAND switch is actuated, the meter pointer will be on scale or not far off scale, and slight adjustment of the OFFSET controls will set the meter pointer to the desired place on the scale. Presetting the OFFSET controls makes it easier to find the segment which includes the input signal and re-

duces the severity of the off-scale meter pointer pinning when an expanded scale is selected.

Four things must be remembered when the expanded scales are used:

1. The setting of the OFFSET controls is arbitrary! Any segment may be chosen. However, only segments which include the input signal are useful.

2. The letter system is a guide to help find the segment which includes the input signal. It is not exact. The actual setting may be as much as two letters away from the indicated setting; especially on the X3 scale. This is normal. It does not affect instrument accuracy.

3. The numbers on the meter scales do not indicate specific frequencies because the segment can be set anywhere along the basic range. However, if the selected segment includes the input signal, the pointer indicates the relative position of the input signal within the segment. If the segment does not include the input signal, the pointer will be off scale.

4. Calibration of the meter scales is determined by the position of the pointer, the basic range selected, and the degree of expansion. For example, if the 1 KC range is expanded X3, the 0-3 scale becomes a 300 cps segment of the 1 KC range. If the pointer is placed over the 2.8 marker by the OFFSET controls, and it subsequently moves to the 1.3 marker, a 150 cps decrease in the input signal is indicated.

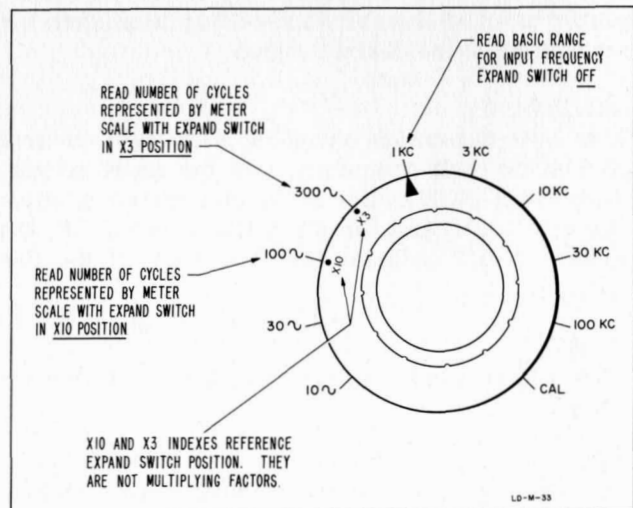

Figure 2B-2. Skirt Markings on Range Switch Dial

The following paragraph describes the use of the expanded scale by following through a differential measurement example.

2B-4 EXAMPLE PROCEDURE

a. Connect the Model 500B to proper source; turn on the power switch and allow five minutes for the instrument to reach a stable operating temperature.

b. Make an unexpanded measurement of the input signal as described in paragraph 2B-2. Assume that the measurement is 700 cps on the 1 KC range, and that ± 100 cps variation is to be observed. Note that the meter pointer rests between D and E on the letter system. See Figure 2B-3.

c. Adjust coarse OFFSET control to the corresponding point between D and E on the letter system around the control.

d. Place EXPAND switch to X3 position. With the EXPAND switch in the X3 position, the 0-3 scale is a 300 cps segment of the 1 KC range.

e. Refine OFFSET adjustment to place pointer at the desired reference. The meter pointer can be placed anywhere on the expanded scale, but to observe the ± 100 cps variation, the pointer must be at least 100 cps from either end of the scale.

Suppose the pointer is placed at "2" on the 0-3 scale. Figure 2B-4 illustrates the resulting calibration of the meter scale.

If the pointer had been placed at "0", then "0" would have become 700 cps, and the meter scale would have displayed a 300 cps segment from 700 cps to 1,000 cps with the 1,000 cps point at "3". In this case, only the +100 cps variation could be observed.

2B-4A EXAMPLE SUMMARY

Control of the meter pointer allows an arbitrary calibration of an expanded scale within a small segment of the basic range. This control establishes a reference point suitable to a particular differential or comparative measurement. In the example developed above, the expanded segment contained 300 cps displayed full scale with an input frequency of 700 cps. Greater pointer excursion occurs per cycle of variation than would occur using the unexpanded 1 KC scale. The greater pointer excursion allows more sensitive observation of fluctu-

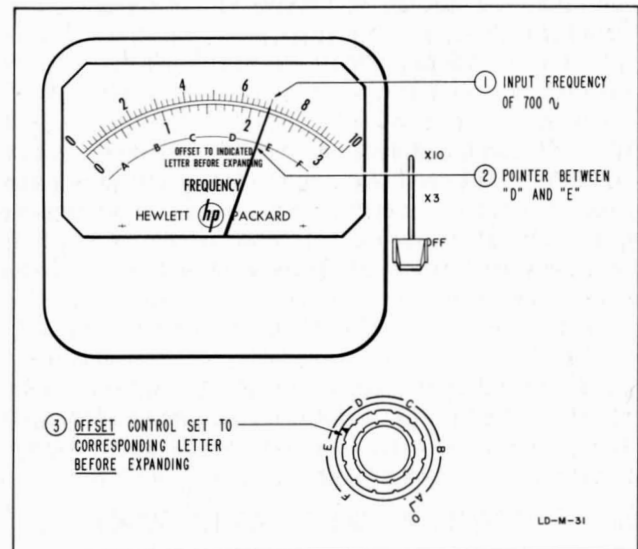

Figure 2B-3. Using Offset Letter System

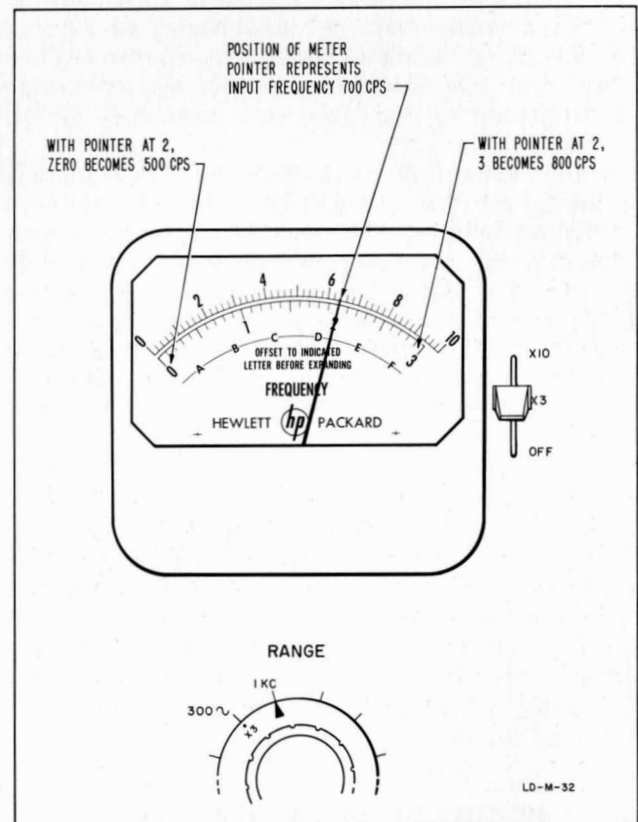

Figure 2B-4. Using "2" As A Reference (0-3 Scale). 1 KC Range Expanded X3

tuations, variations, and drift in the input signal. It displays these changes more accurately than would have been possible on the 1 KC range unexpanded.

In the example above, suppose a ± 50 cps variation was to be observed. X10 expansion could have been used to present an even greater pointer excursion per cycle of variation than that for X3. In the X10 case, the segment would contain only 100 cps (0-10 scale), and the meter pointer (700 cps) would be placed at "5" to allow the variation to be observed.

The amount of variation anticipated on the input signal governs the amount of expansion chosen. Paragraph 2B-6 discusses instrument accuracy for each measurement condition.

2B-5 ADDITIONAL SCALE CALIBRATION METHODS

In the example of paragraph 2B-4 the expanded scale was calibrated with the input frequency for differential measurement.

The accuracy of such a calibration is limited by the basic accuracy of the unexpanded scale used for the initial measurement, i.e. ± 2 percent full scale, but the measurement accuracy of change in frequency is improved (see paragraph 2B-6).

Another method of calibration, useful in random counting, for example (paragraph 2B-7), consists of placing both OFFSET controls fully clockwise. This action calibrates the expanded scale "0" as zero cycles, and calibrates full scale to the magnitude of the segment. For example, the 10 KC range expanded X10 with the OFFSET controls fully clockwise would calibrate the 0 to 10 meter scale from 0 to 1 KC.

Calibration of expanded scale with a known frequency, such as a standard or calibrated oscillator, can also be accomplished to improve the accuracy of expanded scale calibration. In this method an accurate frequency, close to the unknown in magnitude, would drive the instrument to establish a convenient calibration on the expanded scale. This signal would be removed and the unknown signal would be measured on the instrument without changing the OFFSET control.

2B-6 ACCURACY OF MEASUREMENTS

The basic accuracy of measurement on an unexpanded range of the Model 500B is better than

$\pm 2\%$ of full scale value for any range in use. In this discussion the term full-scale, whether or not the scale is expanded, always relates to the frequency value shown under the arrow marker on the RANGE switch dial skirt. This accuracy applies only to single frequency measurement. When differential measurements are made two readings are implicit in the process, and the double liability of error doubles the possible error.

As shown in Table 2B-1, the unexpanded scale accuracy is $\pm 2\%$ full scale for single frequency measurement and is $\pm 3.5\%$ full scale for differential measurement. In examining the various sources for error in the first two columns of the table, it is seen that all errors double in differential measurement, except the circuit calibration error which is linear, always in the same direction, and constant for single or differential frequency measurement.

Moving to the third column, X3, it is seen that the sources for differential error are divided by three - except the phantastron timing error which remains constant. This error is not reduced upon expanding because it arises in the phantastron circuit with line variation. The timing error varies the length of the constant current pulses to produce an erroneous meter indication which is expanded along with the scale expansion so that it remains constant percentage when related to the full-scale range value.

All other errors are related to "pin to pin" meter behavior and remain constant in percentage when related to the number of scale divisions on the meter. The effect is to reduce the percentage full-scale error when the scale divisions are related back to the unexpanded full-scale value. For example, consider meter tracking error on the 100 KC range as $\pm 1\%$. This is $\pm 1/2$ scale division or ± 1000 cps. Expanding the 100 KC range to X10, $\pm 1\%$ then becomes $\pm 1/2$ scale division or ± 100 cps. Relating this 100 cps back to full-scale value, 100 KC, meter tracking error becomes $\pm 0.1\%$: doubled for differential error it becomes $\pm 0.2\%$. Thus, expanded scale error is determined in all cases, except phantastron timing, by dividing the basic range error by the factor of expansion, and then doubling this quantity to obtain total differential error.

The last three columns of Table 2B-1 show maximum possible errors when differential measurements are made with constant line voltage. In these cases the errors arising from line voltage variation become zero.

It should be noted that the line variation (assuming a 115V line) described for the first four columns of the table constitutes a 30-volt fluctuation from 130 volts to 100 volts or from 100 volts to 130 volts, between readings. Most measurement conditions will be better than this with a substantial improvement in the accuracy of the Model 500B.

2B-7 RANDOM COUNTING, GENERAL

During random counting operation several instrument considerations should be kept in mind by the operator: (1) the time constant of the meter, (2) the basic full-scale accuracy of the meter, and (3) a predictable error arising from the nature of the internal pulse forming circuit. These considerations will be discussed in the following paragraphs.

2B-7A METER TIME CONSTANT

Since the random count is averaged over the time constant of the meter, in some applications of measurement the meter pointer may exhibit a tendency to vibrate or oscillate about the average reading. In some cases this vibration may become severe enough to inhibit readings. If this situation occurs it is recommended that a capacitor be placed in the meter circuit to increase its time constant. The capacitor should be placed from the

plus (+) side of the meter to ground. The capacitance used will depend upon the particular application, but 500 μ f has been found sufficient to damp the vibration in most cases. If desired, the Hewlett-Packard Accessory Meter (described in Specifications) could be modified by placing 500 μ f directly across its terminals and used for random counting operation.

2B-7B BASIC ACCURACY

The basic accuracy of the Model 500B/C is $\pm 2\%$ full-scale division. The effect of this error is minimized for the frequency of interest as the pointer approaches a full-scale indication. In measurement operation it is desirable to maintain the pointer as close to a full-scale indication as practicable.

2B-7C PREDICTABLE ERROR

In random counting the possibility of missing an input pulse while the circuit is developing a current pulse from the previous signal constitutes a predictable error. Since the constant current pulse, developed internally, occupies approximately 60 percent of the period time for any given basic RANGE position, unexpanded, a correction factor can be formulated to correct readings.

TABLE 2B-1 MEASUREMENT ERRORS
(Values Shown Are Maximum Possible)

Source of Error	LINE VOLTAGE VARIATION FROM -10% TO +10% DURING MEASUREMENT				LINE VOLTAGE CONSTANT DURING MEASUREMENT		
	Single Frequency Measurement	Differential Measurement Error in % Full Scale			Differential Measurement Error in % Full Scale		
		Error in % Full Scale	Unexpanded	X3	X10	Unexpanded	X3
Current Source	± 0.25	± 0.5	± 0.2	± 0.5	0	0	0
Phantastron Timing Error	± 0.20	± 0.4	± 0.1	± 0.4	0	0	0
Meter Tracking	± 1.00	± 2.0	± 0.6	± 0.2	± 2.0	± 0.6	± 0.2
Circuit Calibration	± 0.50	± 0.50	± 0.2	± 0.05	± 0.5	± 0.2	± 0.05
Expansion Error			± 0.6	± 0.2		± 0.6	± 0.20
Total Possible Error	$< \pm 2.0$	$< \pm 3.5$	$< \pm 2.0$	$< \pm 0.9$	$< \pm 2.5\%$	$< \pm 1.4$	$< \pm 0.45$

If F = random average frequency,
and f_i = indicated frequency,
and f_s = frequency represented by full
scale in use,
and d = width of current pulse
x number pulses,
then $d = .60/f_s(f_i)$.

The time available for counting an input pulse is given by the expression:

$$\text{Time avail.} \approx 1-d \text{ or } 1 - .60 f_i/f_s$$

The random average frequency with no expansion is:

$$F \approx \frac{f_i}{1 - .60 f_i/f_s} \quad (1)$$

With X10 expansion:

$$F \approx \frac{f_i}{1 - .06 f_i/f_s} \quad (2)$$

With X3 expansion:

$$F \approx \frac{f_i}{1 - .2 f_i/f_s} \quad (3)$$

2B-8 RANDOM COUNTING PROCEDURE

a. Place controls in the following positions:

RANGE - 100 KC
EXPAND - X10
OFFSET - both controls to zero, full
clockwise.

Under these conditions the zero position of the OFFSET control calibrates zero on the meter (0-10 scale) so that an absolute reading may be obtained on the expanded scale from zero to 10 KC. The 10 KC range is not used because, as explained in paragraph 2B-7C, 60 percent of the period time of a basic range frequency is used to develop the current pulse and is not available for counting. Less time is used developing the shorter current pulses for the 100 KC range than is used for those developed on the 10 KC range. This means that by expanding you achieve a reading which is closer to the actual random count, since the probable counts missed during the development of the constant current pulses through the meter will be fewer. Thus the correction which is applied as the "predictable error" will be smaller in magnitude. However, unexpanded ranges may be used. The disadvantage is that the readings will be further from the actual count, and the "predictable error" correction will be correspondingly larger.

b. Place the input signal across the INPUT terminals.

c. Note the reading on the meter and step down the RANGE switch as necessary to obtain a satisfactory meter reading. As the RANGE switch is stepped down, f_s in equations (1), (2), and (3) is reduced, and the "predictable error" correction increases. However, the basic meter accuracy - an unpredictable quantity - improves because the meter pointer indicates further upscale as the RANGE switch is stepped down.

d. When the indicated reading has been obtained apply the applicable correction factor from equation (2) for X10 expansion, or equation (3) for X3 expansion.

EXAMPLE

With the instrument set up as described in steps a. and b. above, a measurement is taken and the RANGE switch is stepped down to the 10 KC position. This action places the X10 marking in the RANGE switch dial skirt at 1 KC. The meter reads 4.5. Therefore, it represents an uncorrected average count of 450 cps. Applying equation (2) for a random average count we have:

$$\begin{aligned} F &= \frac{f_i}{1 - .06 f_i/f_s} \\ &= \frac{450}{1 - .06(450)/1000} \\ &= 450/.973 \\ &= 462 \text{ cps} (\pm 1 \text{ scale division}) \end{aligned}$$

2B-9 OPERATING CALIBRATION AND CHECK

Two performance checks are available for the operator in checking the accuracy of the instrument during operation. Perform CAL check first. If two checks cannot be made to agree, see paragraph 4-10.

CALIBRATION (CAL)

This check permits amplitude of the pulse from the constant current source in the meter to be calibrated. The procedure is as follows:

a. Turn on the instrument and permit it to reach a stable operating temperature.

- b. Switch the RANGE control to CAL.
- c. Adjust the CAL ADJ potentiometer with a screwdriver so that the meter indicates full scale (10) on the 0-10 scale.

60 \sim CHECK

This check places 6.3V at power line frequency across the input circuit of the meter.

To perform the check, switch the SENSITIVITY control to the 60 \sim CHECK position and place the RANGE switch to a position which includes the known frequency of the power line. The line frequency should be indicated on the meter.

2B-10 RECORDER OPERATION

The Model 500B will drive any 1 ma, 1400 ohm (± 100 ohm) recorder. When a recorder is used with the instrument the REC ADJ compensating resistor in the instrument must be adjusted to match the resistance of the recorder to that of the meter circuit. The adjustment procedure is as follows:

- a. Allow the 500B to reach a stable operating temperature, and place the SENSITIVITY control in the 60 \sim CHECK position. Adjust the RANGE switch to include the line frequency, and note reading on meter.
- b. Plug recorder into the RECORDER jack and adjust the REC control on the front panel so that the meter indication on the Model 500B is identical to the reading obtained in step a., above.
- c. Use mechanical adjustment on recorder to obtain reading, above, on recorder scale.

When the recorder is removed from the circuit the REC adjusting potentiometer is removed from the meter circuit so that the accuracy of the 500B is unimpaired. The external recorder is placed in series with the meter in the 500B, and it tracks with the meter in the 500B. Thus, expanding a scale on the 500B simultaneously expands the recorder scale.

2B-11 RECORDER JACK RESPONSE

The current at the 500B recorder jack is proportional to the frequency of the input signal. This current is derived from a succession of pulses and is averaged by means of a simple R-C inte-

grating circuit. On low frequency ranges, it is necessary that the integrating time constant be long enough to prevent excessive flutter of the meter or recorder. This integrating also slows down the response of the meter and recorder current to sudden changes in frequency on the low ranges.

For example, on the 10 cps range, the integrating time constant is 200 milliseconds. Thus, when the frequency of the input signal changes suddenly, there will be an observable lag in the response of the meter or recorder. In fact, after 200 milliseconds, the meter needle will have moved only 63 percent of the distance between the old and new readings. It will move 90 percent of the distance in about one and a quarter seconds. If the input frequency varies about its average value in a sinusoidal manner, the output current will also vary sinusoidally about its average value. The amplitude of this current variation will also be reduced by the integrating circuit. An integrating time constant of 200 milliseconds corresponds to a high frequency cut-off of 0.8 cycles-per-second. Thus if the input frequency is varying at a 0.8 cps rate, the resulting current variation will be attenuated by 3 db, and its phase will lag that of the frequency variation by 45 $^{\circ}$.

The table below shows the integrating time constants (T) and cutoff frequency (F_{CO}) for various range settings and expansion conditions on the 500B. The effective rise time (0-90%) of the output current is equal to 2.3T.

RANGE	NO EXPAN.	X3 EXPAN.	X10 EXPAN.
10 \sim	T=200 ms $F_{CO} = 0.8\sim$	18 ms 8.9 \sim	57 ms 3.2 \sim
30 \sim and above	T=5 ms $F_{CO} = 32\sim$	T=18 ms $F_{CO} = 8.9\sim$	57 ms 3.2 \sim

2B-12 PULSE OUTPUT RESPONSE

The voltage from the PULSE output terminal can be used to drive a recorder at higher speeds than are obtainable using the meter current from the recorder jack. It can be used to drive a stroboscope or sync an oscilloscope. The PULSE terminal produces voltage pulses which are identical in shape to the current pulses used in the meter circuit. Since this output signal is direct coupled, it contains a dc component which is proportional to frequency. However, the fact that it consists of

unfiltered pulses allows the user to filter the response as desired.

The PULSE output consists of one negative voltage pulse for every cycle of the input signal. These pulses have an amplitude of -35 volts peak and a constant width such that a full scale meter reading (unexpanded) produces an average voltage of -20 volts. The pulse width is about 6/10 of the period corresponding to a full scale frequency.

For example, on the 100 KC range every input cycle produces an output pulse about 6 microseconds wide and -35 volts high. This pulse is presented at a resistive output impedance of about 23,000 Ω . If the terminal is shunted by a capacity of .01 microfarads, a filter time constant of $RC = 200$ microseconds will result. This will produce a maximum peak-to-peak ripple of $(6/200) \times 35$ volts = 1.05 volts, which is 5.25 percent of full scale. This maximum ripple only occurs at frequencies which correspond to readings at the very low end of the meter scale. The ripple will decrease to about 4/10 of this maximum for full scale readings. Thus, at 100 KC the peak-to-peak ripple would be about 2 percent of full scale if a .01 mfd shunt condenser was used to produce a filter time constant of 200 microseconds. This corresponds to a high frequency cut-off of $1/2 RC = 800$ cps.

This frequency limit can be extended by using a shorter time constant if more ripple can be tolerated. Although the single shunt condenser is the simplest filter for this application, much better results can be obtained with a multi-section filter properly designed to reject signals at the input frequency and higher.

The particular filter to be used depends upon the application. For example, if it is desired to measure the deviation of a 60 KC signal which is being frequency modulated at 1000 cps, a 1000 cps bandpass filter can be used to select to 1000 cps component from the output terminal and present it to an ac voltmeter which can be accurately calibrated in deviation (20 volts = 100 KC on top range.)

2B-13 PULSE OUTPUT APPLICATIONS

How the PULSE output of the frequency meter proves valuable in measurements can be described by assuming that a frequency of 50 KC is to be measured. Assume further that this frequency contains a ± 5 KC frequency modulation swing at a 1 KC

rate and that it is desired to investigate this f-m.

When the frequency-modulated waveform is applied to the frequency meter, the panel meter will indicate the average frequency of 50 KC. For each cycle of the applied frequency, a voltage pulse will be available from the PULSE terminal, as shown in Figure 2B-5. Since the amplitude and width of these pulses are constant, and since the pulses are negative from ground, their short-time average value will vary in exact accordance with the frequency modulation they contain. The original modulating waveform can therefore be recovered if the pulses are averaged with a suitable low-pass filter.

Not only can the waveform be recovered, but the amount of deviation in the signal can readily be measured, because the peak-to-peak amplitude of the variations in the short-time average level will be exactly proportional to the deviation. Since the amplitude and width of the output pulses is such as to give a d-c output level of approximately -20 volts open circuit for a full-scale reading on the

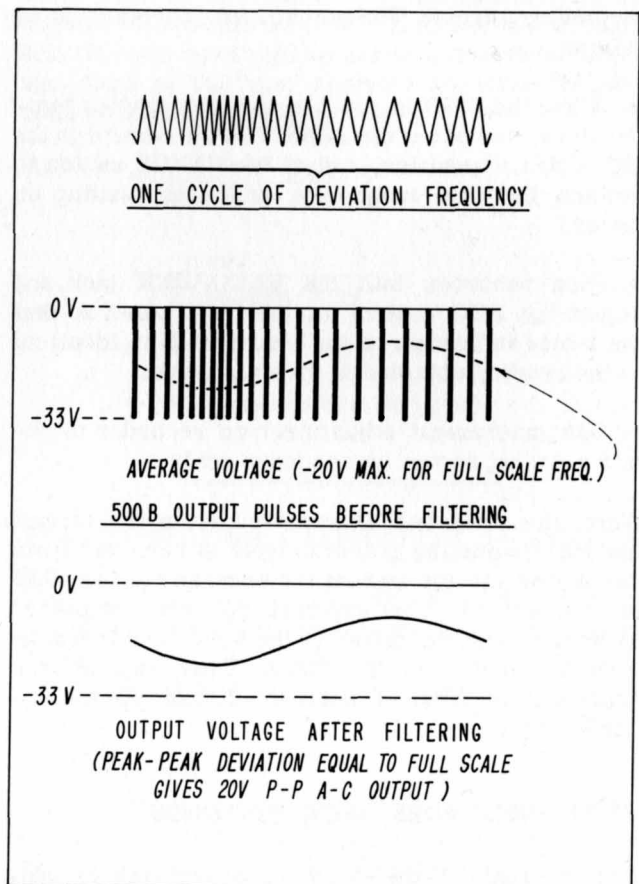

Figure 2B-5. Demodulated FM Signal Recovered from Pulse Output Jack

meter, the applied frequency of 50 KC in this example would cause a half-scale reading on the 100 KC range and therefore an average d-c output of -10 volts or -0.2 volt d-c/KC. By now measuring the peak-to-peak amplitude of the varying component of the d-c output with an oscilloscope or a-c voltmeter, the ± 5 KC deviation in the signal will be found to cause a measured value of 2 volts peak-to-peak.

In practice, these voltages will all be affected by the impedance of the filter used. The voltage per cycle or per kilocycle out of the filter can easily be determined by dividing the measured d-c voltage out of the filter by the reading on the frequency meter.

A filter suitable for the example above and most applications is shown in Figure 2B-5A. The output of this filter is down 3 db at 15 KC, 5 db at 18 KC, 10 db at 20 KC, and more than 55 db at 23 KC and above. The filter need not always be as elaborate as the one shown in Figure 2B-5A; in some cases a single shunting capacitor will do. The cut-off frequency of the filter may be adjusted to any frequency in the audio range, but it must be higher than the modulation frequency and lower than the lowest frequency of the modulated signal.

In order to obtain a fair approximation of the modulation signal from the output of the filter, there should be at least ten pulses into the filter for each cycle of the modulation frequency out of the filter. Thus, the average frequency of the modulated signal applied to the 500B should be at least ten times the modulation frequency. For example, if modulation components up to 5 KC are to be measured, the average frequency supplied to the input of the 500B should be not less than 50 KC.

Figure 2B-6 is an oscillogram of a demodulated f-m signal recovered by using the PULSE output of the frequency meter in the method describe in paragraph 2B-13. The waveform itself is the

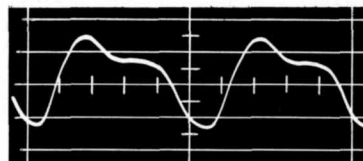

Figure 2B-6. Oscillogram of Incidental FM

incidental f-m modulated into a klystron oscillator from the heater circuit.

2B-14 MEASURING KLYSTRON INCIDENTAL FM

Incidental f-m in the klystron output is translated to the range of the frequency meter by applying the klystron output to an -hp- 540A Transfer Oscillator.¹ The Transfer Oscillator is tuned to produce a difference frequency of 70 KC which also contains the incidental f-m. Test arrangement shown in Figure 2B-7.

The amplitude of the deviation is measured by adjusting the oscilloscope gain to calibrate the scope graticule. In Figure 2B-6 each major division on the graticule is equal to 5 KC of deviation. Total deviation represented by the waveform can thus be seen to be 15 KC peak-to-peak.

The fundamental component of the modulation is 60 cps which is combined with a large amount of second harmonic. If desired, an accurate measurement of each of the components could be made by applying the waveform to an harmonic wave analyzer (Figure 2B-8). If deviations larger than 100 KC peak-to-peak are encountered, the -hp- 520A 100:1 scaler can be connected ahead of the

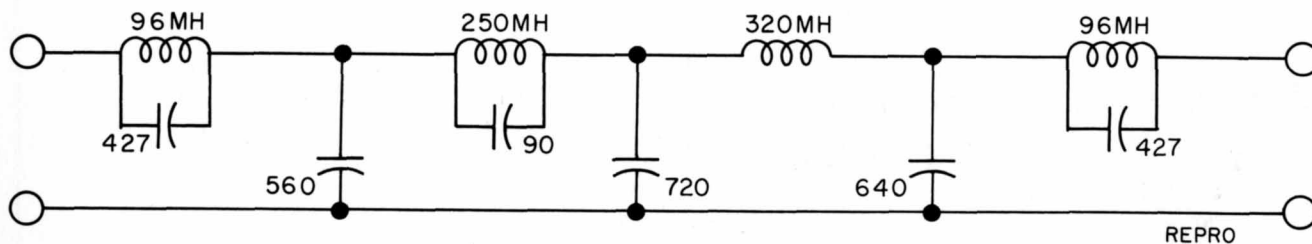

Figure 2B-5A. Low-pass Filter Suitable for Most Applications

1. Dexter Hartke, "A Simple Precision System for Measuring CW and Pulsed Frequencies Up to 12,400 MC", *Hewlett-Packard Journal*, Vol. 6, No. 12, August, 1955.

frequency meter (Figure 2B-9). This will allow deviations of up to 10 MC peak-to-peak to be measured.

2B-15 MEASUREMENT SET-UPS

The 500B frequency meter is a versatile tool for investigating many frequency and stability phenomena. Figures 2B-7 to 2B-11 indicate how the instrument can be combined with other -hp- instruments to measure such quantities as peak-to-peak f-m deviation, components of f-m modulation, stability, and driving voltage recorders.

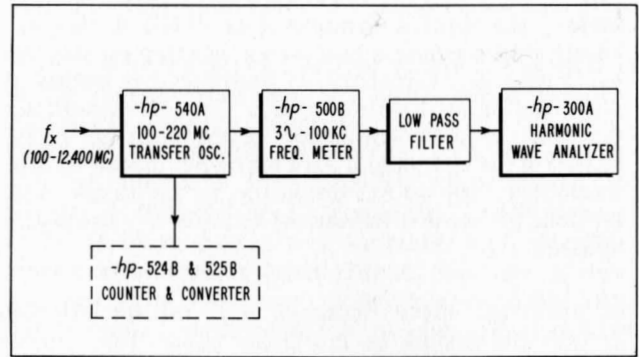

Figure 2B-8. FM Analysis Using Harmonic Wave Analyzer

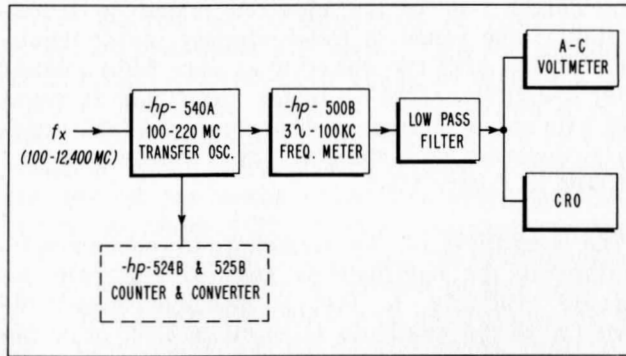

Figure 2B-7. FM Measurement Test Setup

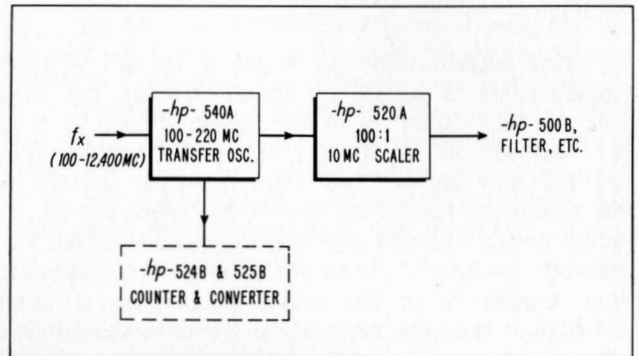

Figure 2B-9. High Frequency FM Measurement Employing Scaler

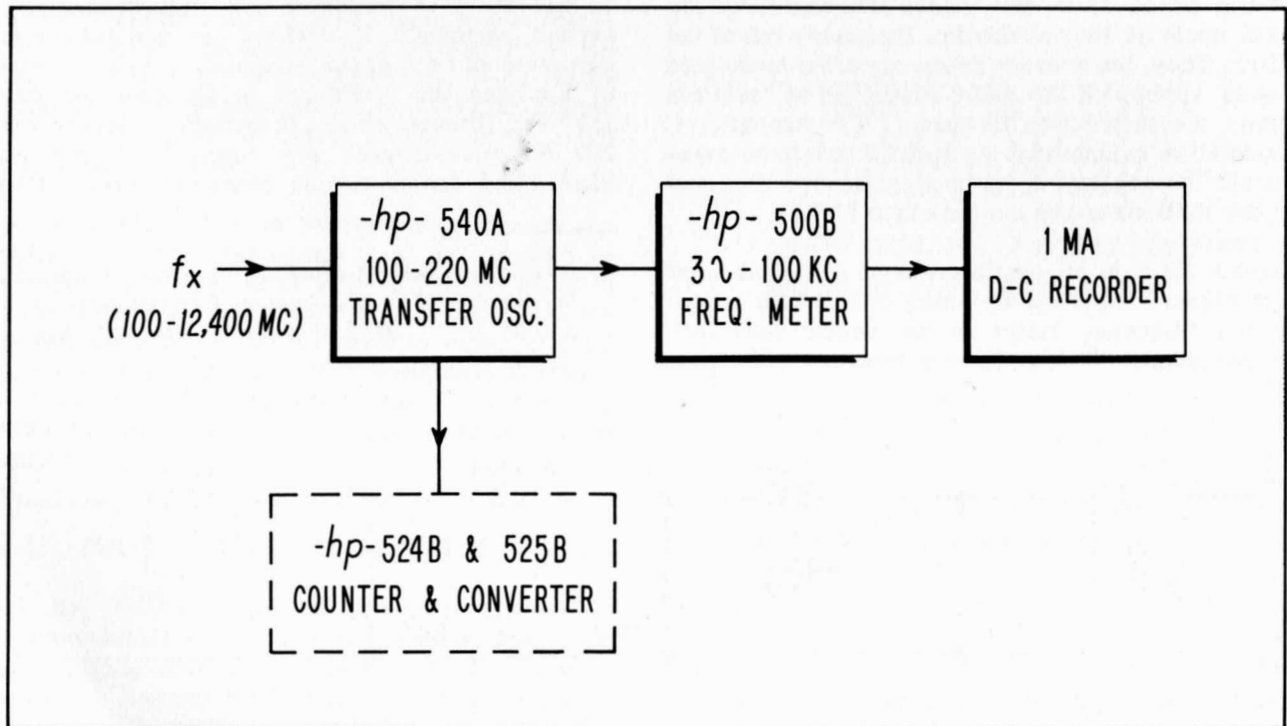

Figure 2B-10. High Frequency Stability Observation Using Recorder

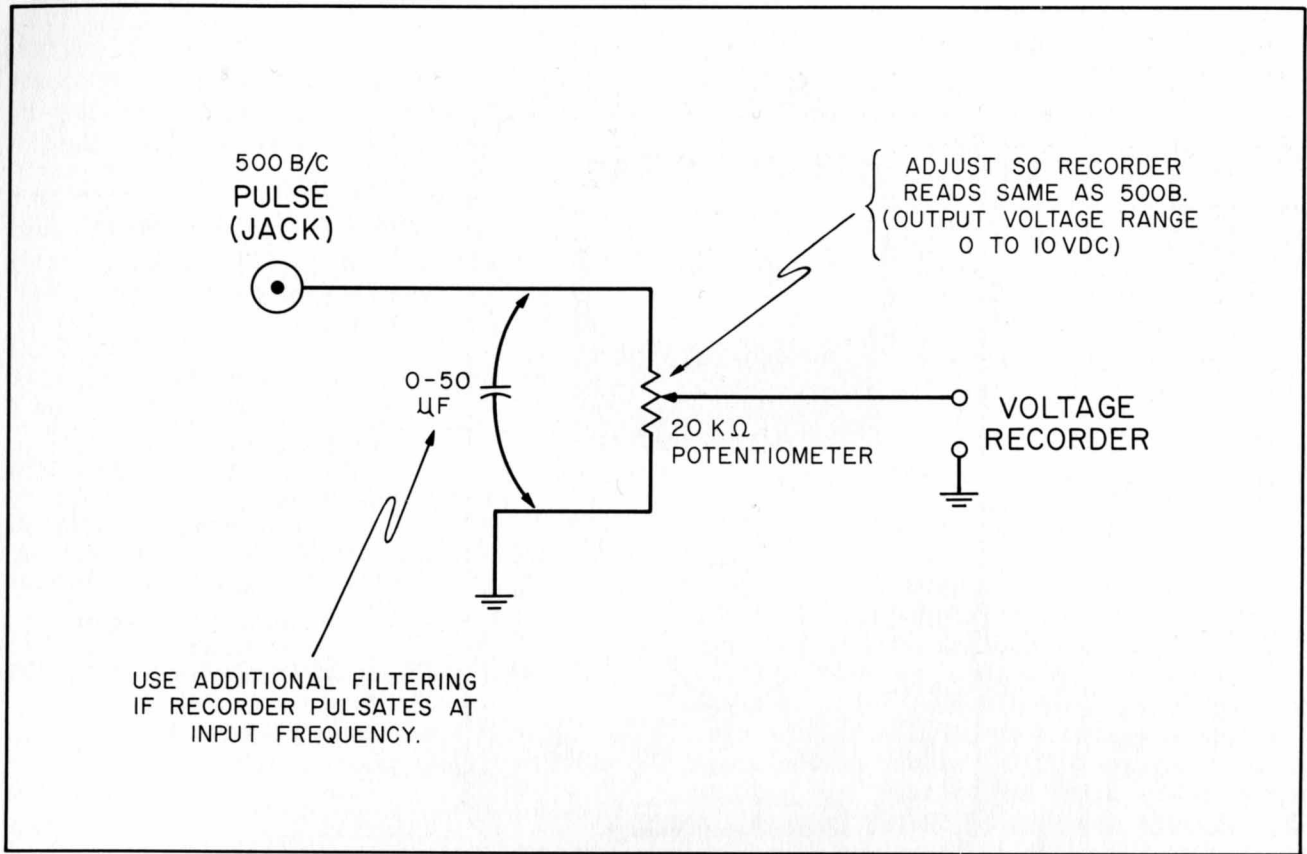

Figure 2B-11. Using Pulse Jack for Operating Voltage Recorder

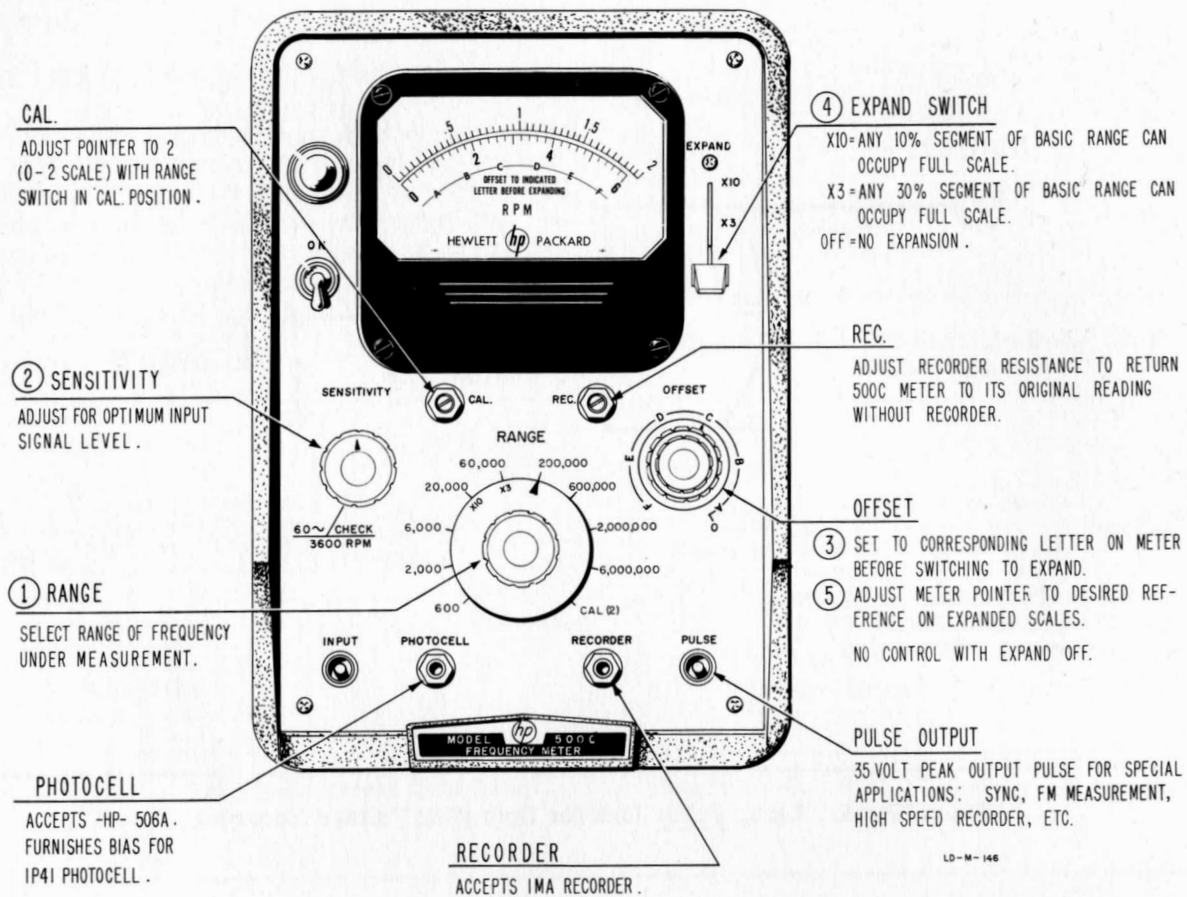

Figure 2C-1. Front View Describing Operating Controls

SECTION IIC
500C OPERATING INSTRUCTIONS
2C-1 CONTROLS AND TERMINALS

SENSITIVITY

This control, normally in the maximum position, is used to decrease the sensitivity of the input amplifier to eliminate errors resulting from spurious modulation of the desired signal.

3600 RPM CHECK

This switch position on the SENSITIVITY CONTROL places the line frequency into the input circuit. With the RANGE switch in the appropriate position (usually 6000) and the EXPAND switch OFF, the meter should indicate 3600 rpm.

RANGE

This rotary switch selects the desired range.

CAL

The CAL position of the RANGE switch checks satisfactory calibration of the constant current source in the circuit by indicating full scale on the 0-2 scale. In this position, input signals have no effect upon the meter.

CAL ADJUST

This screwdriver adjustment is used to calibrate the constant current source. See paragraph 2B-9.

EXPAND

This switch permits expansion to full scale any 10 percent (X10) or any 33 percent (X3) of the basic range in use. Use of the expanded scales is discussed in paragraph 2C-3.

INPUT

This BNC connector accepts any unknown signal from 0.2 to 150 volts rms.

PULSE

This BNC connector is an output terminal providing 35-volt peak pulses out for special applications. See paragraphs 2B-12 and 2B-13.

PHOTOTUBE

This phone-type jack furnishes bias for a 1P41 phototube permitting the direct connection of the -hp- Model 506A Optical Tachometer.

RECORDER

This phone-type jack is provided for connecting a 1 ma recorder to the instrument.

REC ADJ

This screwdriver-operated potentiometer adjusts the effective resistance of a recorder to match the instrument. The adjustment procedure is described in paragraph 2B-10.

2C-2 OPERATING PROCEDURE, COUNTING

- a. Allow a period of five minutes for the instrument to reach a stable operating temperature after turning ON.
- b. Turn the SENSITIVITY control to the maximum clockwise position. Place the EXPAND switch to OFF.
- c. Set the RANGE switch to the 6,000,000 position.
- d. Place signal under test across the INPUT connector.
- e. Step the RANGE switch down from the 6,000,000 position as necessary until the meter pointer rests in the top 2/3 of the meter scale. Decrease the SENSITIVITY control and watch for a change in the reading. The reading should remain constant over a plateau of control to indicate that noise modulation is not being measured as part of the signal under test.

It is necessary with unknown input signals to start the RANGE switch at 6,000,000 and step down, because inputs in excess of the value indicated on RANGE switch can overdrive the instrument causing erroneous readings; i.e.: 120,000 rpm will be erroneously displayed on the 60,000 range, but not on the 200,000 range and above.

2C-3 EXPANDED SCALE, GENERAL

The expanded scale feature allows increased ac-

curacy in the measurement of changes in rpm by magnifying pointer action. The pointer action is magnified by expanding to full scale a 33 percent segment (X3 setting of the EXPAND switch) or a 10 percent segment (X10 setting of the EXPAND switch) of the range selected by the RANGE switch. The particular expanded segment represented by the meter scale is determined by the concentric OFFSET controls, which move the segment between zero and full scale of the basic range. Since the segment selection is arbitrary and the meter pointer always indicates the value of the input signal, the meter pointer will be on scale only if the selected segment includes the frequency of the input signal. The number of rpm in the segment is indicated by the X3 or X10 on the skirt of the RANGE switch (see Figure 2C-2).

A letter system helps find the segment which includes the input signal; the letters are marked both on the meter face and around the OFFSET controls. When an unexpanded measurement is made, the meter pointer indicates a point on the letter system as well as the value of the input signal, and the coarse OFFSET control should be set near that point of the letter system before the EXPAND switch is actuated. When the EXPAND switch is actuated, the meter pointer will be on scale or not far off scale, and slight adjustment of the OFFSET controls will set the meter pointer to the desired place on the scale. Pre-setting the OFFSET controls makes it easier to find the segment which includes the input signal and reduces the severity of the off-scale meter pointer pinning when an expanded scale is selected.

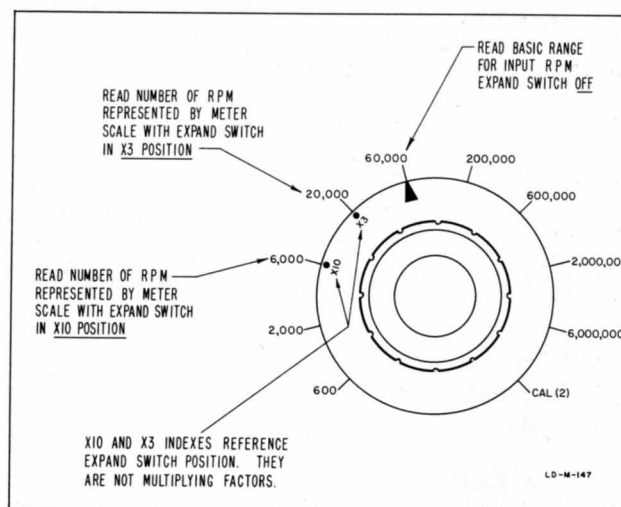

Figure 2C-2. Skirt Markings on Range Switch Dial

Four things must be remembered when the expanded scales are used:

1. The setting of the OFFSET controls is arbitrary! Any segment may be chosen. However, only segments which include the input signal are useful.
2. The letter system is a guide to help find the segment which includes the input signal. It is not exact. The actual setting may be as much as two letters away from the indicated setting; especially on the X3 scale. This is normal. It does not affect instrument accuracy.
3. The numbers on the meter scales do not indicate specific speeds because the segment can be set anywhere along the basic range. However, if the selected segment includes the input signal, the pointer indicates the relative position of the input signal within the segment. If the segment does not include the input signal, the pointer will be off scale.
4. Calibration of the meter scales is determined by the position of the pointer, the basic range selected, and the degree of expansion. For example, if the 60,000 range is expanded X3, the 0-2 scale becomes a 20,000 rpm segment of the 60,000 range. If the pointer is placed over the 1.8 marker by the OFFSET controls, and it subsequently moves to the 0.4 marker, a 14,000 rpm decrease in the input signal is indicated.

The following paragraph describes the use of the expanded scale by following through a differential measurement example.

2C-4 EXAMPLE PROCEDURE

- a. Connect the Model 500C to proper source; turn on the power switch and allow five minutes for the instrument to reach a stable operating temperature.
- b. Make an unexpanded measurement of the input signal as described in paragraph 2C-2. Assume that the measurement is 42,000 rpm on the 60,000 range, and that ± 6000 rpm variation is to be observed. Note that the meter pointer rests between D and E on the letter system. See Figure 2C-3.
- c. Adjust coarse OFFSET control to the corresponding point between D and E on the letter system around the control.
- d. Place EXPAND switch to X3 position. With the EXPAND switch in the X3 position, the 0-2 scale is a 20,000 rpm segment of the 60,000 range.
- e. Refine OFFSET adjustment to place pointer at

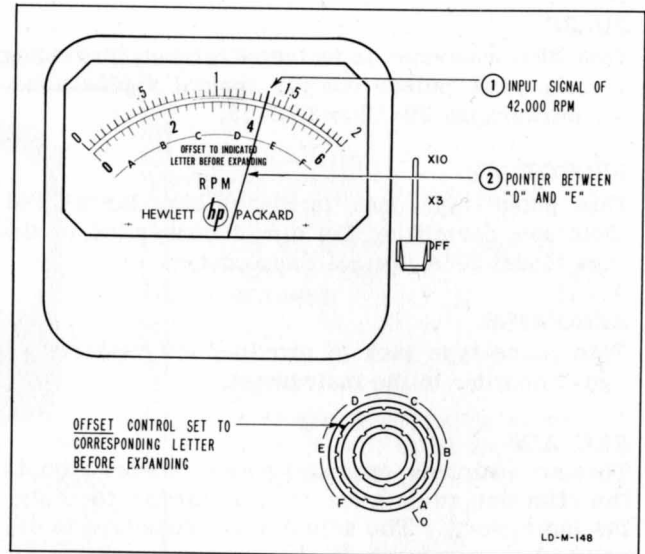

Figure 2C-3. Using Offset Letter System

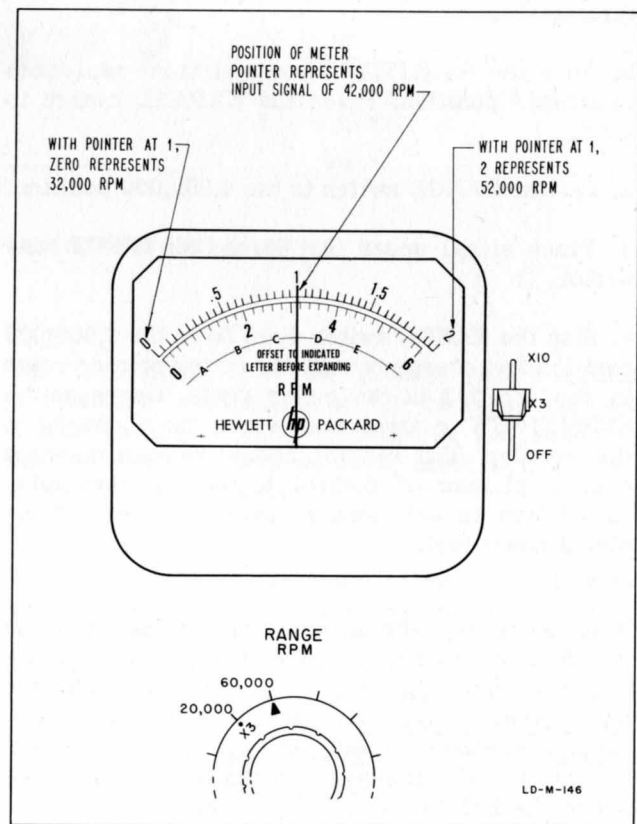

Figure 2C-4. Using "1" as A Reference (0-2 Scale). 60,000 Range Expanded X2

the desired reference. The meter pointer can be placed anywhere on the expanded scale, but to observe the ± 6000 rpm variation, the pointer must be at least 6000 rpm from either end of the scale.

Suppose the pointer is placed at "1" on the 0-2 scale. Figure 2C-4 illustrates the resulting calibration of the meter scale.

If the pointer had been placed at "0", the "0" would have become 42,000 rpm, and the meter scale would have displayed a 20,000 rpm segment from 42,000 rpm to 62,000 rpm with the 62,000 rpm point at "2". In this case, only the +6000 rpm variation could be observed.

2C-4A EXAMPLE SUMMARY

Control of the meter pointer allows an arbitrary calibration of an expanded scale within a small segment of the basic range. This control establishes a reference point suitable to a particular differential or comparative measurement. In the example developed above, the expanded segment contained 20,000 rpm displayed full scale with an input frequency of 42,000 rpm. Greater pointer excursion occurs per revolution of variation than would occur using the unexpanded 60,000 scale. The greater pointer excursion allows more sensitive observation of fluctuations, variations, and drift in the input signal. It displays these changes more accurately than would have been possible on the 60,000 rpm range unexpanded.

In the example above, suppose a ± 3000 rpm variation was to be observed. X10 expansion could have been used to present an even greater pointer excursion per revolution of variation than that for X3. In the X10 case, the segment would contain only 6000 rpm (0-6 scale), and the meter

pointer (42,000 rpm) would be placed at the 3.0 marker to allow the variation to be observed.

The amount of variation anticipated on the input signal governs the amount of expansion chosen. Paragraph 2B-6 discusses instrument accuracy for each measurement condition.

NOTE

The 500B and 500C instruments are identical except for meter and range switch calibration. On the 500B, the meter and range switch are calibrated in cycles per second. On the 500C, the meter and range switch are calibrated in revolutions per minute. Thus the two instruments are operated in the same way, and identical results are obtained from identical inputs. For example, the 500B will display a 500 cps input as 500 cps; the 500C, with the same input, will display 60×500 or 30,000 rpm, which is equivalent to 500 cps.

The paragraphs above (2C-1 through 2C-4A), which pertain only to the 500C, parallel exactly paragraphs 2B-1 through 2B-4A, which pertain to the 500B. Section IIC is written to avoid any confusion which might arise from attempting to operate the 500C from the 500B operating instructions. However, paragraphs 2B-5 through 2B-15 will not be duplicated for the 500C. Simply remember to convert cycles per second to revolutions per minute when applying these paragraphs to the 500C. This means that the input frequency in cps multiplied by 60 will give the reading obtained on the 500C.

SECTION III THEORY OF OPERATION

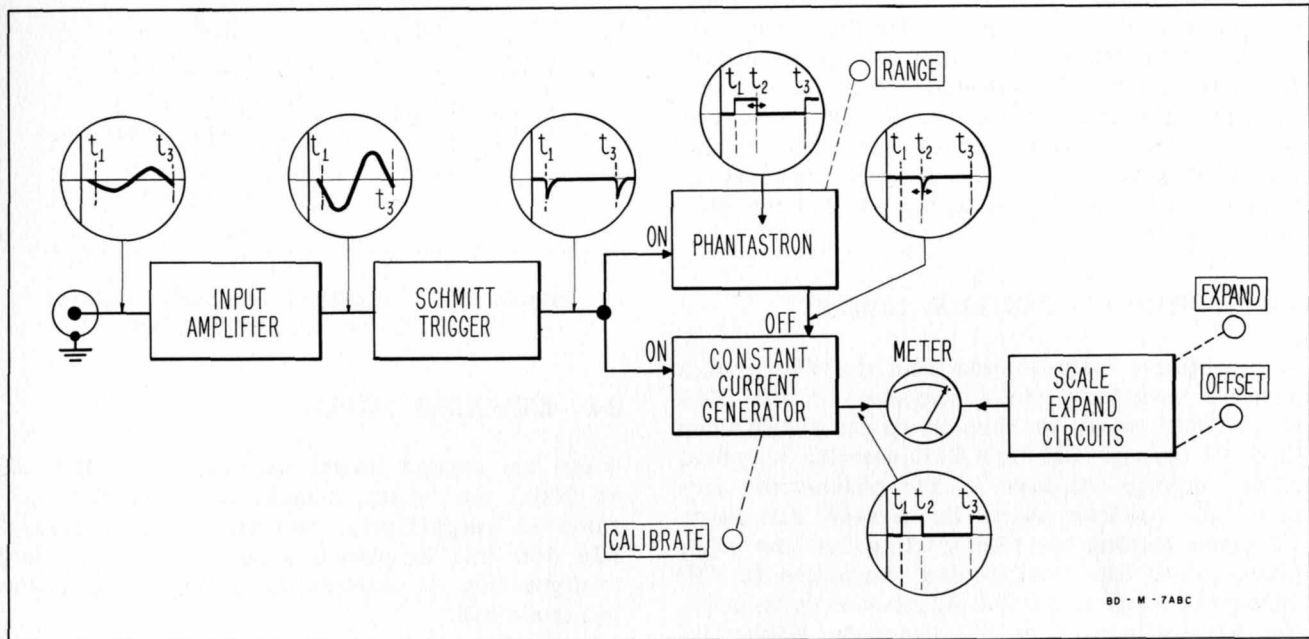

Figure 3-1. Block Diagram of Circuit Elements

3-1 INTRODUCTORY

This section describes circuit operation for the Model 500B by discussing each element of the block diagram shown in Figure 3-1.

3-2 INPUT AMPLIFIER, V1

V1 is a conventional differential amplifier with V1A acting as a cathode follower driving the cathode of V1B. Since there is no variation in the V1B grid source (bias network consisting of R8 R9, R11), V1B acts as a grounded grid amplifier.

Bias for V1A and V1B is provided by the network R4, R8, R9, and this bias is fixed at ac ground through C3. Because V1A has no plate load it tends

to conduct more current than V1B so the bias network furnishes more bias for V1A than for V1B and equalizes the plate currents in the two sections. The output signal from the input amplifier is coupled to the Schmitt Trigger through C5.

3-3 SCHMITT TRIGGER, V2

V2 is a Schmitt Trigger, conventional in all respects except in the use of C6, which permits the amplitude of the output wave leading edge to be greater than that normally encountered in the conventional circuit.

The positive going portion of the trigger output is eliminated by one-half V3, while the negative going portion is differentiated by C7 and R20 and

passed through the other half V3 as a negative spike to the V4A grid.

The sensitivity of the trigger is adjusted by R12 which adjusts the no signal voltage on the V2A grid.

3-4 SWITCHING MULTIVIBRATOR, V4

V4 is a one shot cathode coupled multivibrator. In the no signal condition V4A conducts while V4B is cut off. A negative spike from the trigger V2 cuts off V4A causing the rapid switch in conduction to V4B associated with multivibrators of this type. However, V4 is not a true multivibrator because it does not return to the no signal state of its own accord. Recovery is determined by the action of the phantastron circuit, V5 - V7.

3-5 SWITCHING CONTROL CIRCUIT

As a negative trigger spike hits the V4A grid, a positive switching pulse appears on the V4A plate. This pulse is coupled to the phantastron tube V5 through C11 and C12, starting a typical Miller voltage rundown in the phantastron circuit¹. At rundown start, the screen voltage on V5 rises holding the V4B grid against the diode clamp V7A, thus maintaining conduction in V4B during the rundown period. At rundown completion, the screen voltage on V5 descends cutting off V4B. The period of the rundown is fixed by the RC time constant selected by S1, RANGE switch.

Phantastron action, therefore, causes V4B to develop a current pulse during conduction which is stable in length. At the same time degenerative action of the V4 cathode resistor and the action of the clamp V7A causes the current pulse to be stable in amplitude. One such stable pulse is passed through the meter circuit for each input cycle. The meter averages the pulses it receives and presents an indication proportional to average frequency.

1. An excellent discussion of the phantastron circuit may be found in Terman, F. E. and Pettit, J. M., *ELECTRONIC MEASUREMENTS*, 2nd edition, McGraw-Hill Book Co., New York, 1952.

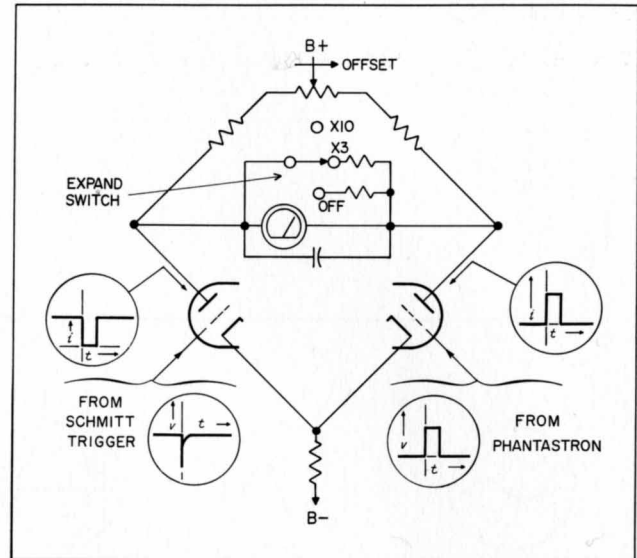

Figure 3-2. Simplified Schematic Showing Switching Action of V4

3-6 EXPANDED SCALE

When the expand switch is placed in either X3 or X10, the meter shunts, R32 and R30, are removed respectively, and the OFFSET control R24 and R25 is placed across the meter. This configuration is essentially a bridge as shown in Figure 3-2.

The two halves of V4 conduct alternately and represent two arms of the bridge. The input frequency determines the current ratio in which the tubes conduct. The bridge is balanced for the input frequency with the OFFSET control to keep the meter pointer on scale. Resistor R27 preserves the calibration of the meter circuit over the range of OFFSET control.

3-7 CALIBRATION

When the Range switch S1 is placed in the CAL position the circuit action is as follows: The grid of V4B, the Switching Multivibrator is disconnected from the -320 volt bus and rises against the V7A clamping voltage. This allows V4B to conduct through the meter circuit, while V4A is cut off. The amount of current through V4B is then adjusted by means of R35 in its cathode circuit. The amount of current through V4B determines the amount of current flowing through the meter and the OFF position shunt

of the EXPAND switch S2. This shunt consists of R31 and R32.

The meter is calibrated when the steady cur-

rent through the meter circuit from V4B produces a full scale deflection (or 10) on the meter. Adjusting R35 will produce this calibration.

SERVICING ETCHED CIRCUIT BOARDS

Excessive heat or pressure can lift the copper strip from the board. Avoid damage by using a low power soldering iron (50 watts maximum) and following these instructions. Copper that lifts off the board should be cemented in place with a quick drying acetate base cement having good electrical insulating properties.

A break in the copper should be repaired by soldering a short length of tinned copper wire across the break.

Use only high quality rosin core solder when repairing etched circuit boards. NEVER USE PASTE FLUX. After soldering, clean off any excess flux and coat the repaired area with a high quality electrical varnish or lacquer.

When replacing components with multiple mounting pins such as tube sockets, electrolytic capacitors, and potentiometers, it will be necessary to lift each pin slightly, working around the components several times until it is free.

WARNING: If the specific instructions outlined in the steps below regarding etched circuit boards without eyelets are not followed, extensive damage to the etched circuit board will result.

1. Apply heat sparingly to lead of component to be replaced. If lead of component passes through an eyelet in the circuit board, apply heat on component side of board. If lead of component does not pass through an eyelet, apply heat to conductor side of board.

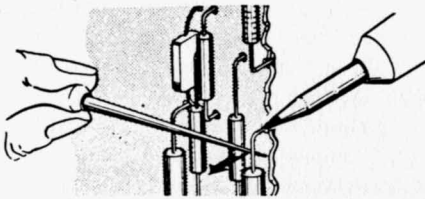

2. Reheat solder in vacant eyelet and quickly insert a small awl to clean inside of hole. If hole does not have an eyelet, insert awl or a #57 drill from conductor side of board.

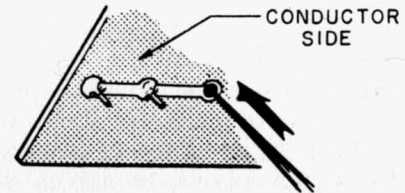

3. Bend clean tinned leads on new part and carefully insert through eyelets or holes in board.

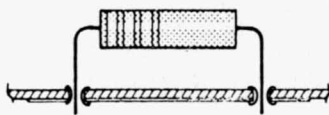

4. Hold part against board (avoid overheating) and solder leads. Apply heat to component leads on correct side of board as explained in step 1.

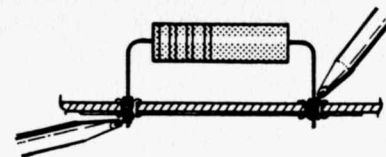

In the event that either the circuit board has been damaged or the conventional method is impractical, use method shown below. This is especially applicable for circuit boards without eyelets.

1. Clip lead as shown below.

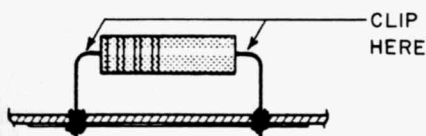

2. Bend protruding leads upward. Bend lead of new component around protruding lead. Apply solder using a pair of long nose pliers as a heat sink.

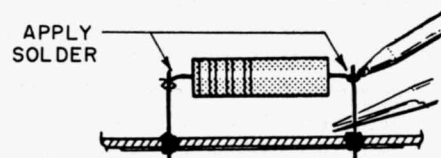

This procedure is used in the field only as an alternate means of repair. It is not used within the factory.

Figure 4-1. Servicing Etched Circuit Boards

SECTION IV MAINTENANCE

4-1 INTRODUCTORY

This section contains instructions for maintaining and trouble shooting the Model 500B as well as procedures for tube replacement and internal adjustment. A tube replacement chart describes adjustments necessary after tube replacement, and a trouble shooting chart contains procedures for checking instrument performance section by section to assist in localizing most troubles which may occur.

COMPREHENSIVE CHECK

After you replace tubes or otherwise restore instrument to operation you may want to make a complete check for optimum performance. If this is the case, perform the procedures given in the reference paragraphs below in the following order:

Paragraph 4-8
Paragraph 4-6
Check waveforms in Figure 4-6

Paragraph 4-9
Paragraph 4-11
Paragraph 4-10

4-2 CABINET REMOVAL

To remove the instrument from the case, remove two machine screws from the rear of cabinet. Pull front panel forward from the case. (The bezel remains attached to the front panel of the instrument.)

4-3 EQUIPMENT REQUIRED

Test procedures in this section attempt to isolate as many probable difficulties as possible with a minimum of equipment. The nature of the instrument, however, requires the following equipment to be available.

APPLICATION

Power supply adjustment; dc voltage and resistance measurement.

Range calibration and phantastron adjustment.

Signal tracing.

EQUIPMENT

20,000 ohm/volt multimeter or dc VTVM, such as -hp- Model 410B.

Accurate test oscillator to 100 KC with at least 10 volt signal output, such as -hp- 200 series.

AC VTVM, wide frequency range, such as -hp- Model 400 series.

4-4 TUBE REPLACEMENT

Tubes used in the Model 500B are listed in Table 4-1, following. A tube may be replaced with any tube of its type having standard characteristics. The tubes which involve circuit adjustment when replaced are accompanied by a reference to the applicable paragraph in this section of the manual.

4-5 TROUBLE LOCALIZATION

The conservative design of the Model 500B means that normal aging has little effect on operation. Tube replacement and adjustment should repair the majority of difficulties which may develop in the instrument. Isolation of circuit failures is frequently possible by considering the sections, shown in Figure 3-1, and observing the effects of front panel controls on instrument behavior. Electrical trouble shooting should be preceded with a visual inspection. Look for signs of damage, burned out components, overheating, or looseness of parts which, if not failure sources themselves, suggest areas of future trouble. A cold tube found simply by touch may save considerable time and effort in restoring the instrument to

operation. The tube location, voltage and resistance diagram, Figure 4-7, is frequently of assistance in localizing unknown difficulties.

The trouble shooting chart in paragraph 4-7 describes checks to be performed which locate specific symptoms, together with possible causes and remedies.

All electrical trouble shooting should start with the power supply.

4-6 POWER SUPPLY

Proper operation of the power supply is vital to proper operation of the Frequency Meter. Variation in the regulated voltages causes the instrument to operate in an unusual or erratic manner. Make resistance and voltage checks of power

supply first when the instrument is suspected of marginal operation.

To check the regulated power supply voltage, place EXPAND switch OFF and measure the dc voltage from across the -320 bus on the printed wiring card to chassis. Adjust this voltage if necessary with R78 shown in Figure 4-1 to -320 volts $\pm 2\%$. This voltage should remain regulated to $\pm 1\%$ over a line voltage range from 105 to 125 volts ac or V12 current change. Check step 1 of the trouble shooting chart in the next paragraph for specific failures.

Check other power supply voltages shown in Figure 4-1. Deviations here in excess of $\pm 10\%$ could indicate a value change in the voltage divider resistors, R80, R81, or R82 shown in the schematic diagram.

TABLE 4-1 TUBE REPLACEMENT

TUBE	TYPE	FUNCTION	ADJUSTMENT REQUIRED
V1	12AT7	Input amplifier	No adjustment
V2	5965	Schmitt trigger	Adjust R12, Para. 4-9
V3	6AL5	Diode clipper	No adjustment.
V4	6463	Multivibrator	Adjust CAL, front panel
V5	5725	Phantastron	Readjust R57, Para. 4-10. For best performance allow V5 to age for 72 hours in instrument before readjusting R57; Para. 4-10.
V6	5965	Cathode follower	Usually none, Para. 4-10.
V7	6AL5	Clamp	Adjust CAL, front panel; Para. 4-10
V8	5Y3GT	Rectifier	No adjustment.
V9	6AL5	Rectifier	No adjustment.
V10	6AU5GT	Series regulator	No adjustment.
V11	6CB6	Control tube	Check -320 volt supply.
V12	OB2	Reference tube	Check -320 volt supply regulation with VR current change. See Table 4-2, step 1.
V13	NE-2	Reference tube	Check +90 volt supply
V14	NE-2	Reference tube	Check +90 volt supply.

When the EXPAND switch is in X3 or X10 all supply voltages vary with the position of the OFFSET control. Thus the exact B+ voltage labeled +1 volts dc on the schematic diagram is a function of the OFFSET control position. With the EXPAND switch OFF this voltage is nearly zero. When checking this voltage place the instrument in expand X3 and vary the OFFSET control. The voltage should vary between ≈ 1 and +35 to 40 volts dc.

4-7 TROUBLE SHOOTING CHART

For simplification in Table 4-2, Trouble Shooting Chart, only tubes are referenced, but it should

be remembered that components associated with referenced tubes are also failure possibilities. The maintenance steps in the chart should be performed in the specified order since the chart assumes that the section ahead of the one under investigation is operating correctly.

For all testing of the Model 500B the use of a variable transformer to adjust the line voltage between 105 and 125 volts is recommended. An instrument in satisfactory condition should operate over this range. An instrument having marginal operation (from weak tubes etc.) can be quickly detected at low line voltages, and such weaknesses become easier to trace.

TABLE 4-2 TROUBLE SHOOTING

CHECK AND SYMPTOM	POSSIBLE CAUSE	REMEDY
1. POWER SUPPLY		
Measure B- voltage (-320 volt)		
Slight deviation:	R78 out of adjustment.	With R78, Figure 4-3, adjust B- to -320V to within $\pm 2\%$.
High voltage:	Defective control tube V11.	Replace tube; adjust R78 as above; see paragraph 4-6.
Low voltage:	Defective rectifier or regulator V8 or V10.	Replace; adjust R78 as above; see paragraph 4-6.
Erratic voltage:	Defective reference tube V12.	Replace; adjust R78 as above; see paragraph 4-6.
Variation in B- with change in regulator.		
Observe changes in B- while switching RANGE switch from 100 KC position to CAL position with 100 KC input signal.		
Repeat:		
Changes greater than ± 1 volt:	Defective V12.	Replace V12.
2. INPUT SECTION		
Make 60 \checkmark check after CAL adjust.		
Slight deviation ($\pm 5\checkmark$):	Phantastron out of adjustment.	Adjust R57; see paragraph 4-10.

TABLE 4-2 TROUBLE SHOOTING (Cont'd.)

CHECK AND SYMPTOM	POSSIBLE CAUSE	REMEDY
2. INPUT SECTION (Cont'd.)		
<p>No 60λ check, erratic or large deviation:</p> <p>If instrument fails to operate after power supply check</p> <p>Place 10 volt, 50 KC test signal into INPUT jack. SENSITIVITY control, max.</p> <p>a. If instrument indicates 50 KC with 10V signal.</p> <p>b. Instrument indicates 25 KC or reads high (same deflection all ranges).</p> <p>c. Instrument fails to operate with 10V; 50 KC signal.</p>	<p>Defective V2, phantastron, or trigger adjustment.</p> <p>R12 out of adjustment.</p> <p>Defective input amplifier V1.</p> <p>Defective trigger tube V2.</p> <p>Proceed to PHANTASTRON section, this table.</p> <p>V1, V2, V3, V4. See check below.</p>	<p>Compromise between CAL adjustment and R57 adjustment (within specification) may be necessary.</p> <p>Proceed with checks in this section of chart to isolate trouble.</p> <p>Adjust Schmitt sensitivity, paragraph 4-9.</p> <p>Replace; see Table 4-1.</p> <p>Replace; see Table 4-1.</p> <p>Be sure input section is satisfactory by obtaining same behavior with ≈ 1 volt input signal. Correct input sensitivity troubles, if present, before going to phantastron.</p> <p>Replace; see Table 4-1.</p>
3. ADDITIONAL CHECK		
<p>With 10V; 50 KC input, measure ac voltage from pin 3, V4 to chassis. Use wide frequency range VTVM. Voltage should be ≈ 2 vac. (Using 20,000Ω/volt multi-meter good indication generally less than 1 vac).</p> <p>a. Signal present at pin 3, V4. Instrument does not operate.</p> <p>b. Signal not present at pin 3, V4.</p>	<p>Defective multivibrator (current switching tube) V4.</p> <p>V1, V2, V3.</p>	<p>Replace; see Table 4-1.</p> <p>Replace; see Table 4-1.</p>
4. PHANTASTRON		
<p>CAL adjust control range inadequate. (Meter pins upscale)</p>	<p>Defective V7.</p>	<p>Replace; see Table 4-1.</p>

TABLE 4-2 TROUBLE SHOOTING (Cont'd.)

CHECK AND SYMPTOM	POSSIBLE CAUSE	REMEDY
PHANASTRON (Cont'd.)		
With no signal applied and SENSITIVITY control set ccw but not in 60 \checkmark CHECK position, measure dc voltages at pin 2 (cathode) and pin 7 (grid 3) of V5. The voltage at pin 7 should be approximately 11 volts more negative than the voltage at pin 2.		
Incorrect voltage	R45 out of adjustment	Adjust phantastron, para. 4-10

4-8 METER ZERO ADJUSTMENT

a. With instrument turned off adjust mechanical zero on front of meter. Turn adjusting screw continuously clockwise and approach zero from on scale.

b. Turn instrument ON.

c. Controls as follows:

EXPAND X10

OFFSET Both controls to zero (full clockwise).

Input Signal None

RANGE Optional

d. If meter does not read zero, check all leakage paths to ground (e.g.: C1, C3, C23).

4-9 ADJUSTING SCHMITT TRIGGER SENSITIVITY

a. Turn input SENSITIVITY control to maximum (CW).

b. Apply low level signal to INPUT jack. (This signal needs only enough amplitude to operate the instrument approximately 1 volt at any frequency within the range of the instrument.)

c. Decrease the input SENSITIVITY control until the instrument shows insufficient signal effects, and stops indicating.

d. Adjust R12, shown in Figure 4-2, back and forth to find those limits between which the instrument reads properly. Center R12 between these limits. (Adjustment should be nearly correct at this point.)

e. Refine the adjustment as follows: Reduce input SENSITIVITY control again until meter ceases to indicate. Adjust R12 to find exact point where instrument operates. If none exists increase SENSITIVITY control slightly and adjust R12 to exact operation point.

4-10 ADJUSTING PHANASTRON

Before any phantastron adjustments check power supply voltage and adjust if necessary, and calibrate the instrument as described in para. 2B-9.

a. With instrument operating set SENSITIVITY control to 60 cycle CHECK position.

b. If instrument fails to indicate exact line frequency adjust R57 to produce line frequency indication.

NOTE

The adjustment of R57 will correct phantastron circuit timing for small deviations in reading resulting from slight tube changes, component aging and small value changes. Large discrepancies indicate that either V5, V6 or V7 is at fault or some of their associated components.

- c. Rotate SENSITIVITY control clockwise out of 60 cycle CHECK and remove any input.
- d. Connect a vtm, such as Model 412A across pin 2 and pin 7 of V5. The voltmeter must be isolated from ground or have a floating input.
- e. Adjust R45 until the voltage at pin 7 (grid 3) is -11 volts with respect to pin 2 (cathode).

4-11 METER SHUNT ADJUSTMENTS

These adjustments are only necessary in the case of a wirewound resistance drift or replacement in the meter circuit. Specifically: R23, R25-R32 or R38.

The procedure assumes the instrument to be in proper working order in all other respects. Adjustment is accomplished as follows:

- a. Carry out meter zero procedure in paragraph 4-8.
- b. With meter zero procedure completed set controls as follows:

EXPAND -- X10

OFFSET -- Zero. (Both controls full clockwise)

RANGE -- 1 KC

- c. Place an oscillator signal of approximately 100 cps into 500B INPUT terminal.

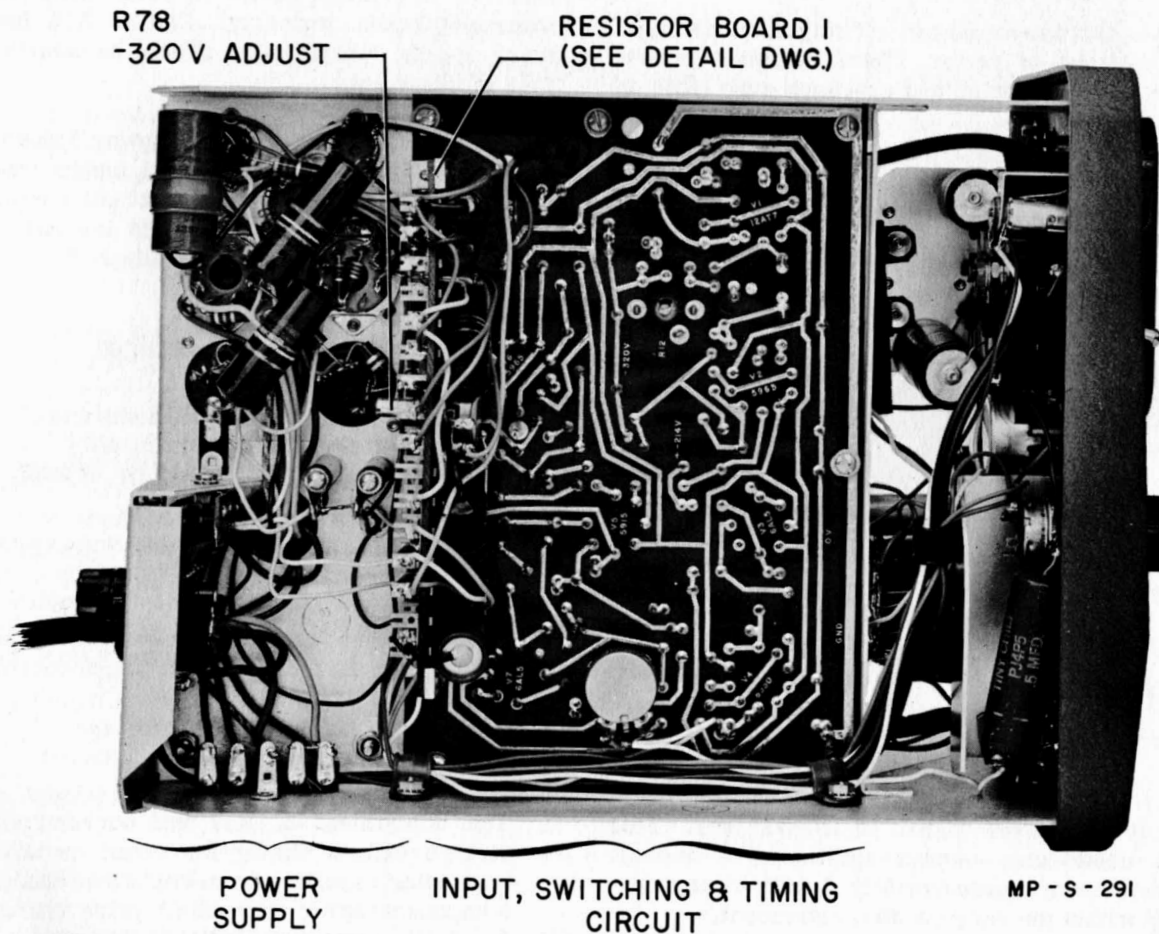

Figure 4-1. Right Side View of Instrument Showing Power Supply

- d. Use frequency control on oscillator to set 500B meter pointer right on some scale mark near full scale. Note exact frequency used.
- e. Switch EXPAND to OFF.
- f. Increase frequency of signal from oscillator

exactly 10 times.

- g. Adjust R31, shown in Figure 4-2, so that pointer indicates same reference mark established in step d.

This completes X10 shunt adjustment.

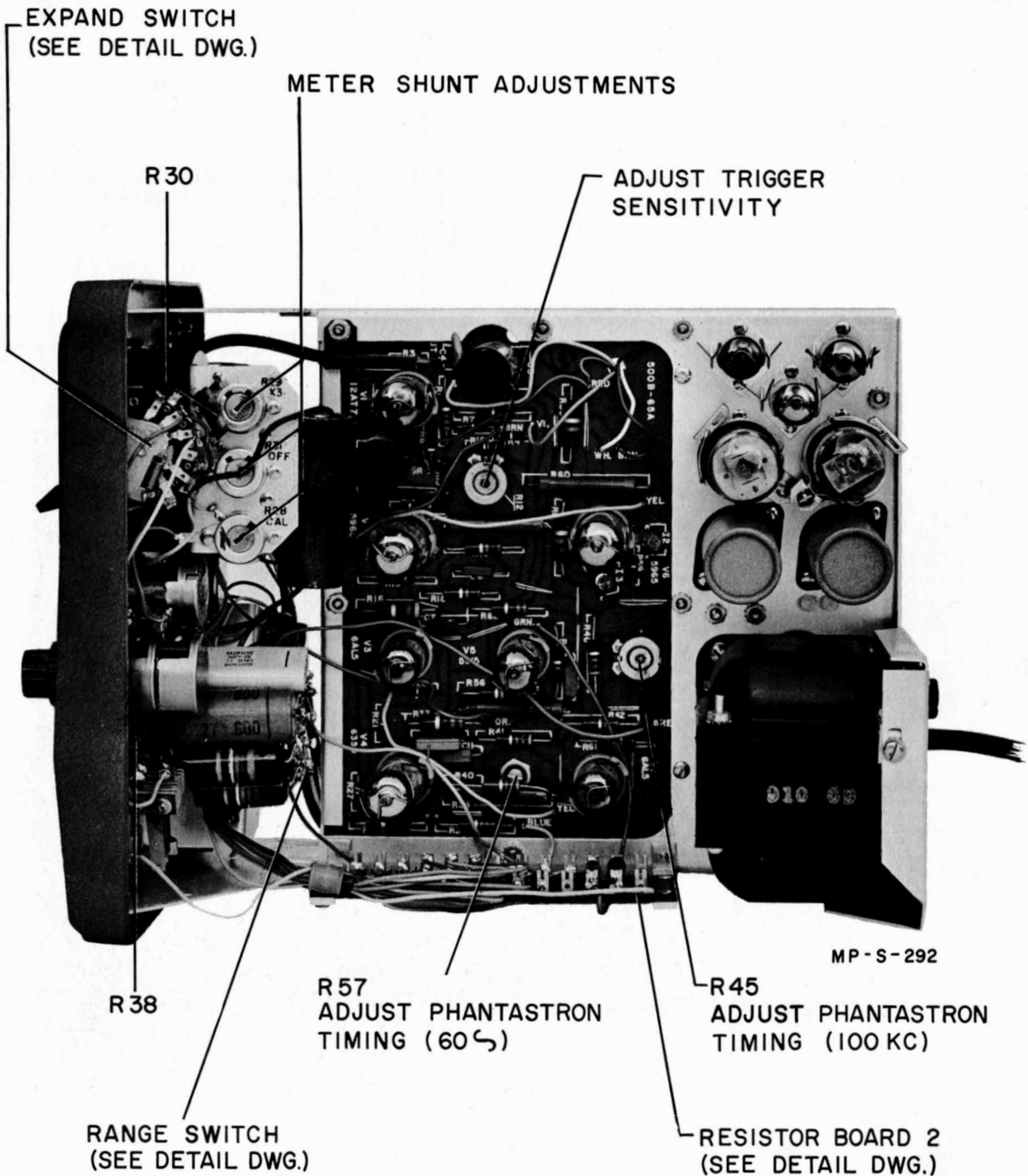

Figure 4-2. Left Side View of Instrument Showing Adjustments

h. To adjust X3 shunt, set controls as follows:

EXPAND -- OFF

OFFSET -- Remains zero. (Both controls fully clockwise.)

RANGE -- 100 cps.

i. Place an oscillator signal of exactly 100 cps into 500B INPUT terminal. Adjust R57, shown in Figure 4-2, if necessary so that meter pointer indicates exactly "10".

j. Reduce frequency of oscillator signal to exactly 30 cycles and switch EXPAND to X3.

k. Set meter pointer on 500B to exactly "3" with R29, shown in Figure 4-2.

This completes X3 shunt adjustment.

l. To adjust the CAL shunt set controls as follows:

EXPAND -- OFF

RANGE -- CAL

CAL -- Mechanical center.

m. Adjust 500B meter pointer to "10" (calibrate reading) with R28, shown in Figure 4-2.

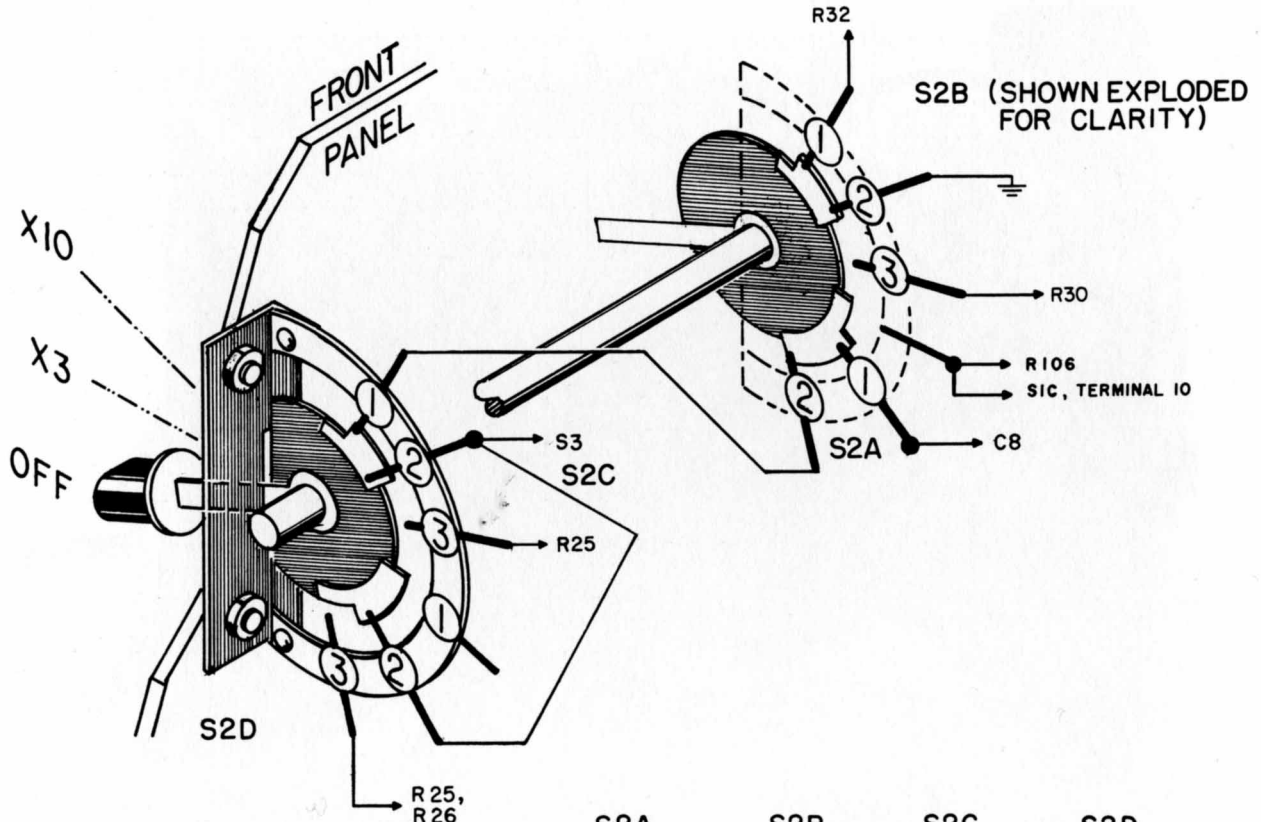

	S2A	S2B	S2C	S2D
(SHOWN) A OFF	①+②	①+②	①+②	②
B X3	②	②+③	②+③	②+③
C X10	—	③	②+③	③

SCHEMATIC POSITIONS

CONTACT SHORTS POSITIONS SHOWN

LD - S - 45AB

Figure 4-3. Detail of Expand Switch

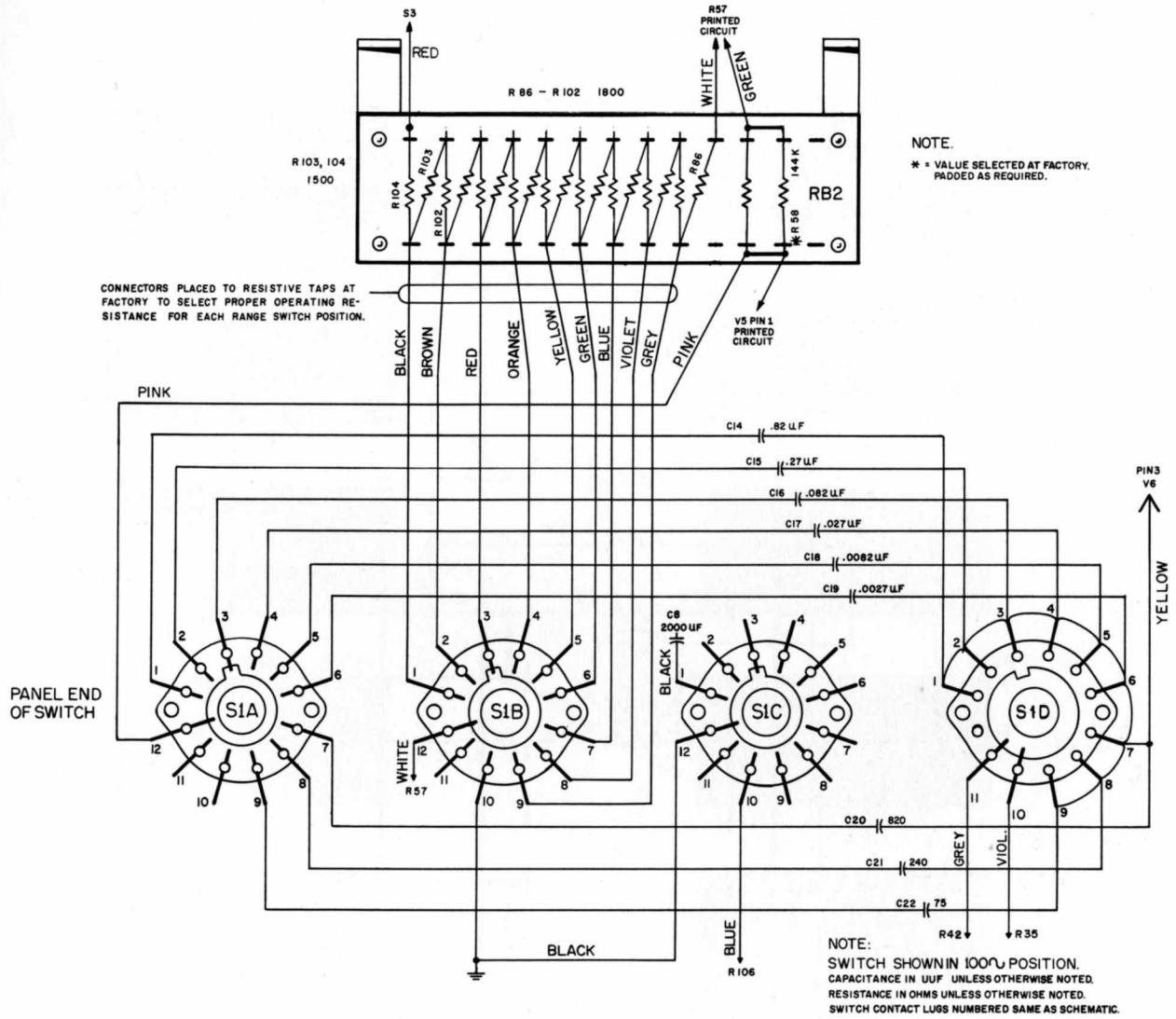
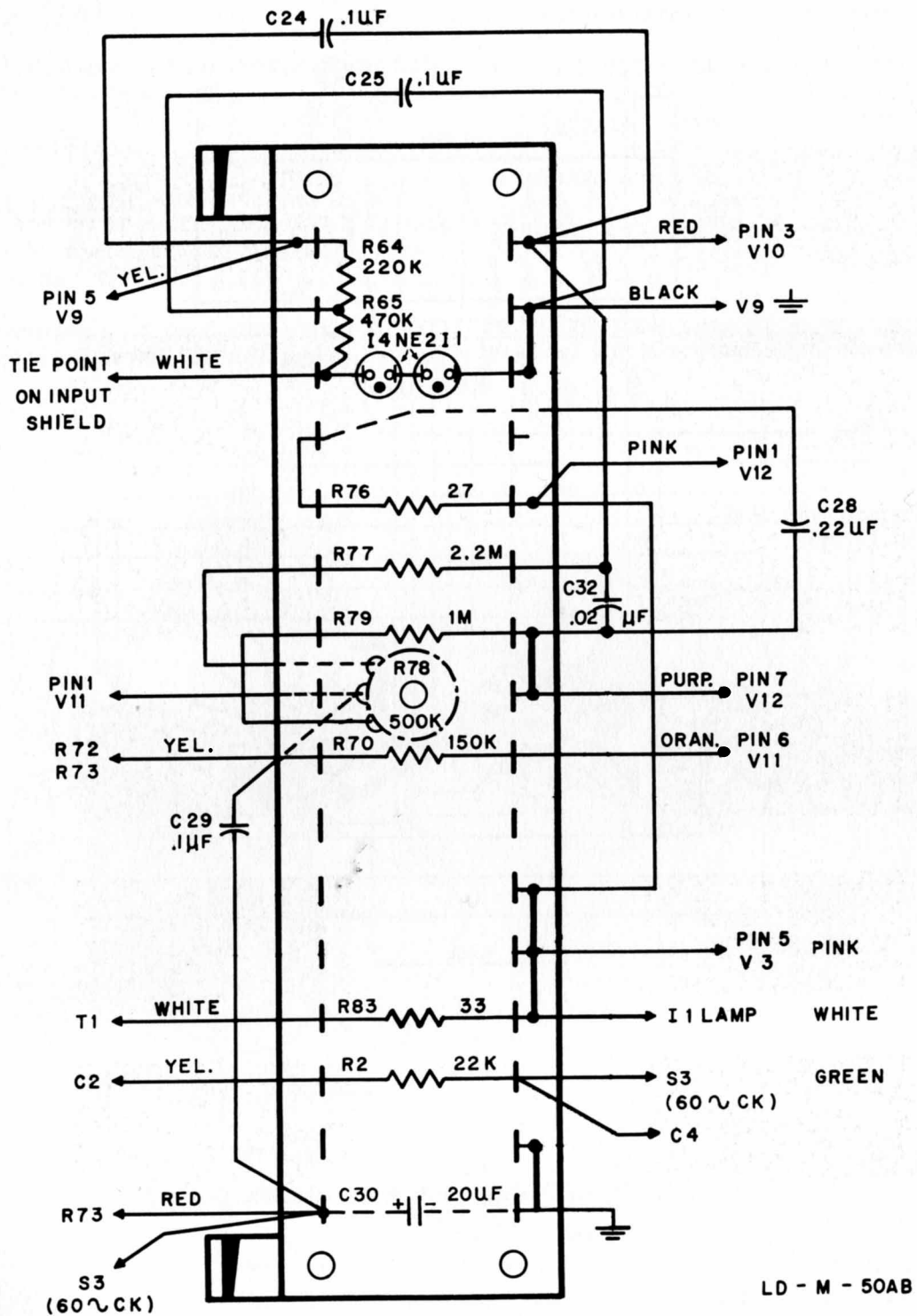

Figure 4-4. Detail of Range Switch and Resistor Board 2



LD - M - 50AB

Figure 4-5. Detail of Resistor Board 1

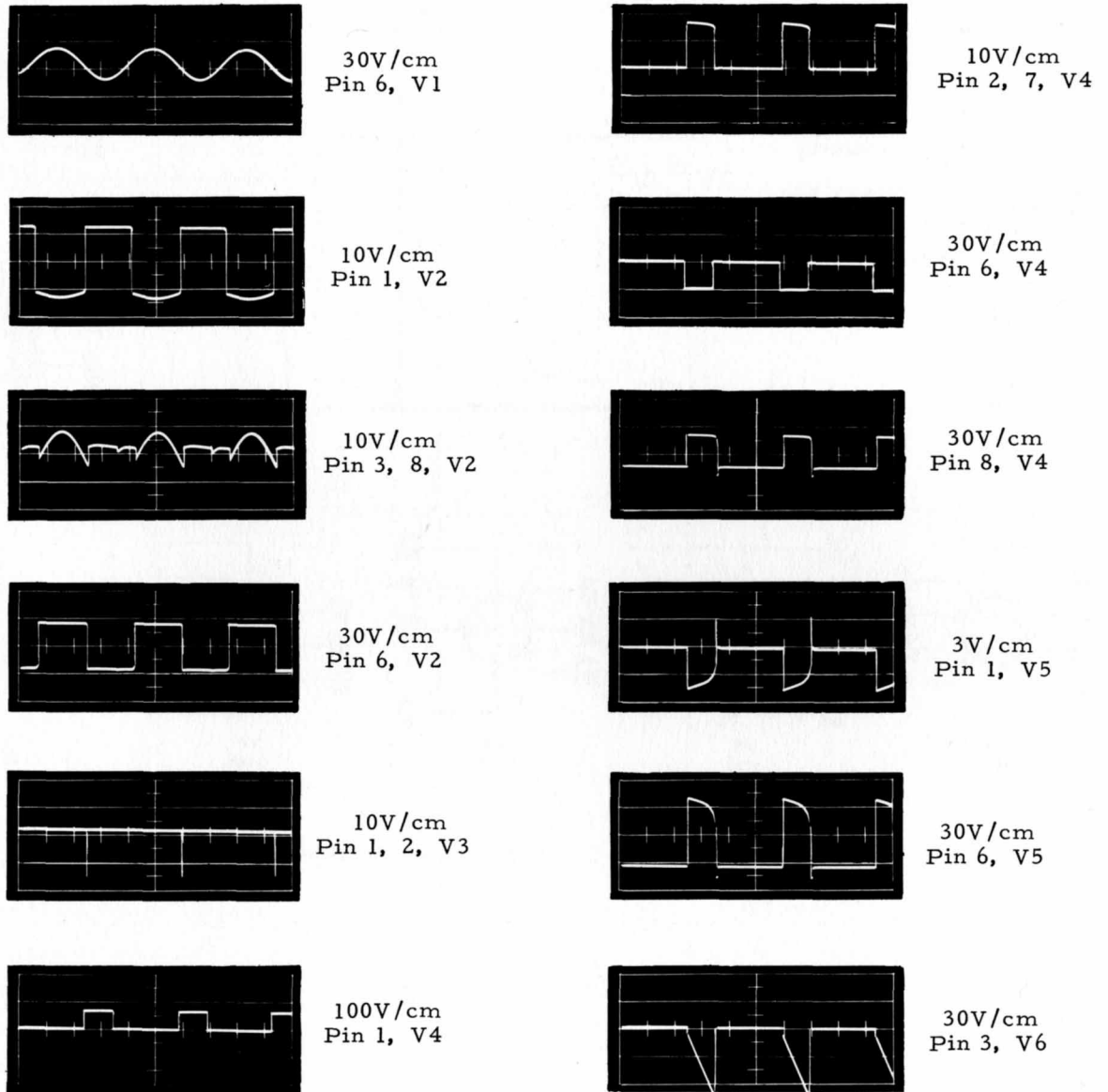

Figure 4-6. Oscilloscope Waveforms

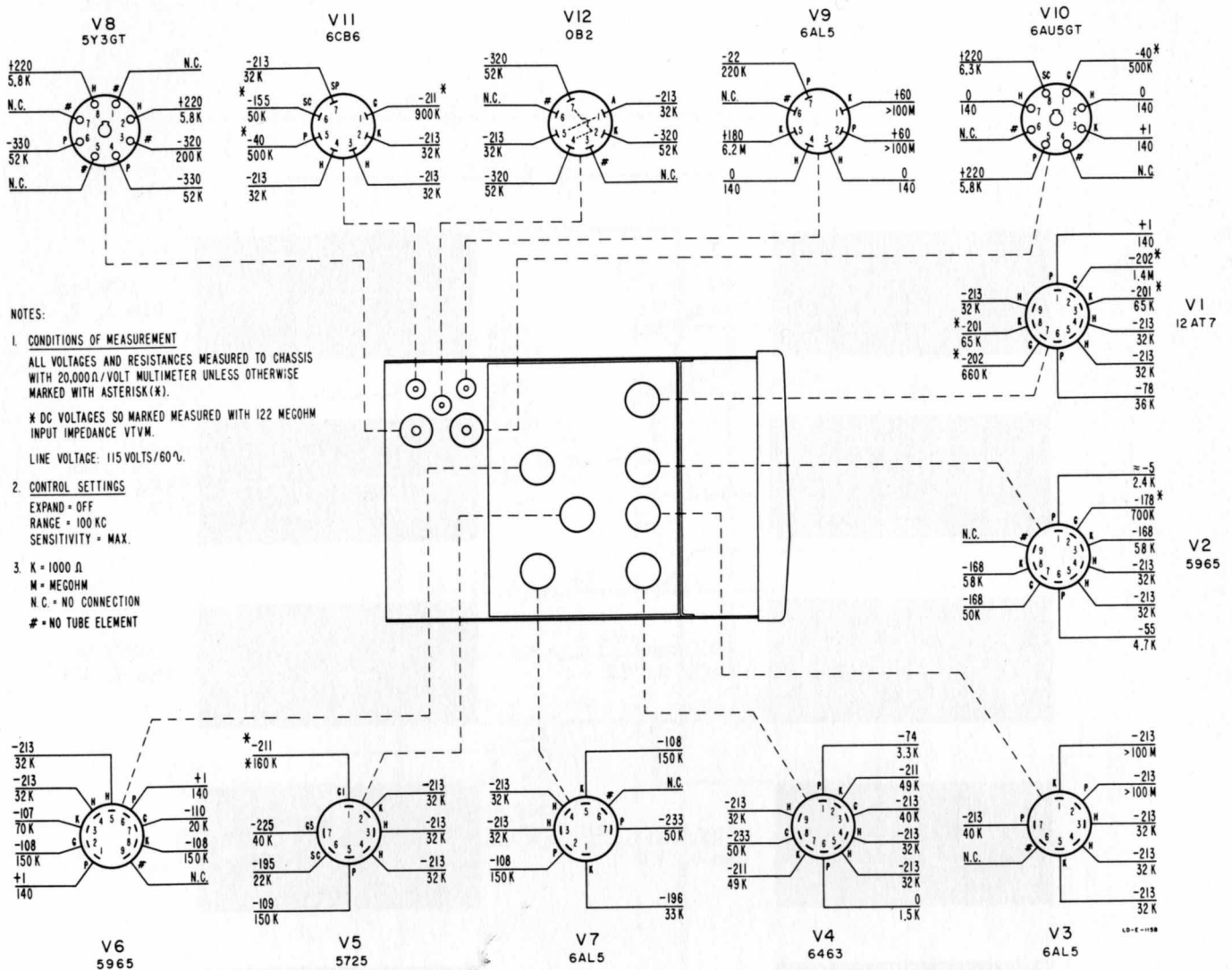
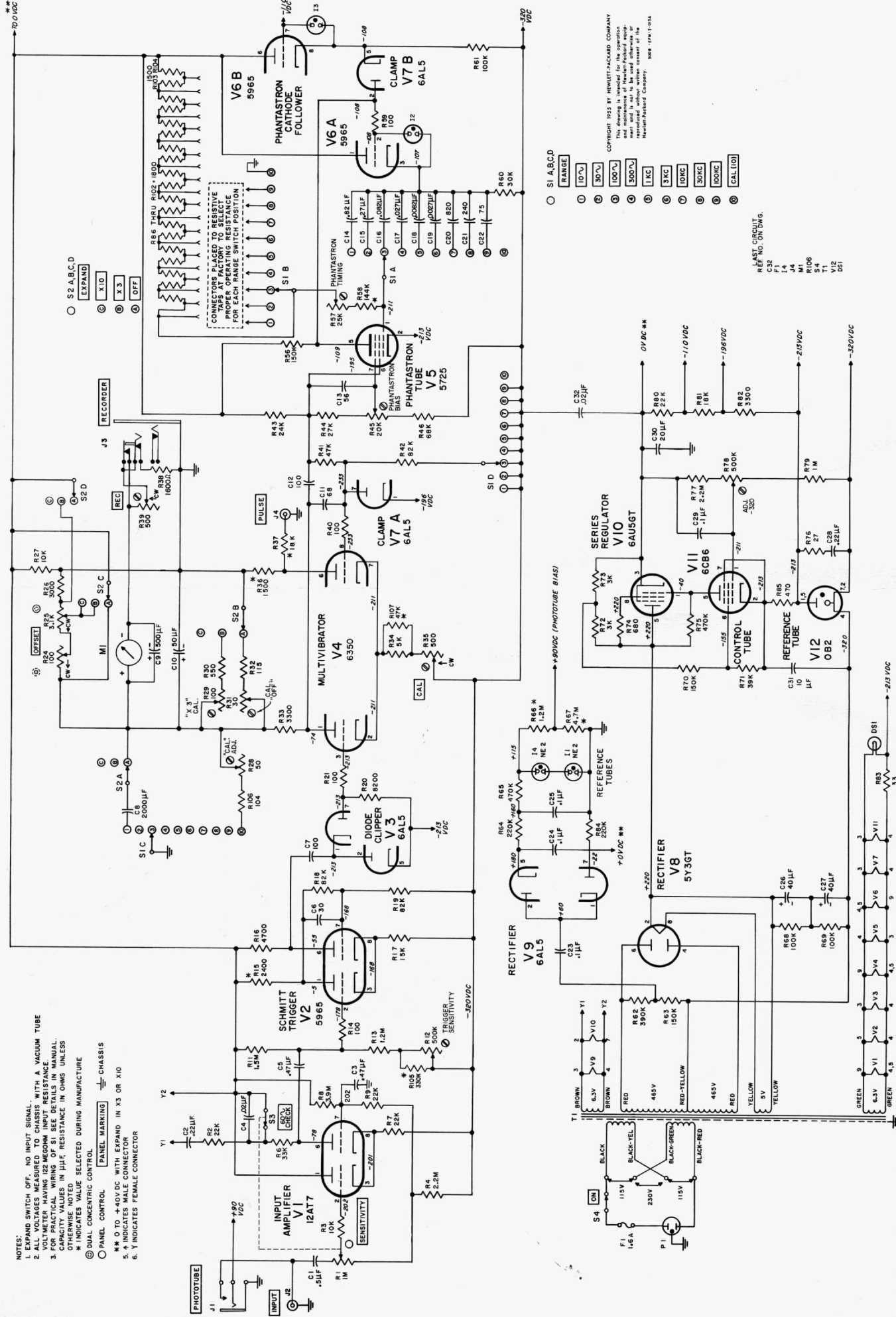

Figure 4-7. Tube Location, Voltage and Resistance Diagram



- NOTES:
- NO INPUT SWITCH OFF. NO INPUT SIGNAL.
 - ALL VOLTAGES MEASURED TO CHASSIS WITH A VACUUM TUBE VOLTMETER HAVING 122 MEGOHM INPUT RESISTANCE.
 - FOR PRACTICAL WIRING OF S1 SEE DETAILS IN MANUAL. CAPACITY VALUES IN μ UF. RESISTANCE IN OHMS UNLESS INDICATED OTHERWISE.
 - * INDICATES VALUE SELECTED DURING MANUFACTURE.
 - ⊙ DUAL CONCENTRIC CONTROL.
 - ⊙ PANEL CONTROL.
 - ⊙ PANEL MARKING.
 - ⊙ CHASSIS.
 - ** 0 TO +40V DC WITH EXPAND IN X3 OR X10.
 - * INDICATES MALE CONNECTOR.
 - ⊙ INDICATES FEMALE CONNECTOR.

○ S1 A, B, C, D

RANGE	VALUE
1	10 μ V
2	30 μ V
3	100 μ V
4	300 μ V
5	1.0K
6	3.0K
7	10K
8	30K
9	100K
10	CAL 100

COPYRIGHT 1955 BY HEWLETT-PACKARD COMPANY
 This drawing is intended for the operation and maintenance of the Hewlett-Packard equipment shown. It is not to be reproduced without written consent of the Hewlett-Packard Company. 9081-128-11054

LAST CIRCUIT
 CSE. NO. ON DWG.
 F1
 L4
 M1
 M4
 R106
 S4
 T1
 T2
 D51

SECTION V

TABLE OF REPLACEABLE PARTS

NOTE

Standard components have been used in this instrument, whenever possible. Special components may be obtained from your local Hewlett-Packard representative or from the factory.

When ordering parts always include:

1.  Stock Number.
2. Complete description of part including circuit reference.
3. Model number and serial number of instrument.
4. If part is not listed, give complete description, function and location of part.

Corrections to the Table of Replaceable Parts are listed on an Instruction Manual Change sheet at the front of this manual.

RECOMMENDED SPARE PARTS LIST

Column RS in the Table lists the recommended spare parts quantities to maintain one instrument for one year of isolated service. Order complete spare parts kits from the Factory Parts Sales Department. ALWAYS MENTION THE MODEL AND SERIAL NUMBERS OF INSTRUMENTS INVOLVED.

12-1-59

TABLE OF REPLACEABLE PARTS

Circuit Ref.	Description	Mfr. *	 Stock No.	TQ	RS		
C1	Capacitor: fixed, paper, 0.5 μ f \pm 10%, 400 vdcw	14655	0160-0024	1	1		
C2	Capacitor: fixed, paper, 0.22 μ f \pm 10%, 400 vdcw	56289	0160-0018	1	1		
C3	Capacitor: fixed, paper, 0.47 μ f \pm 10%	14655	0160-0042	2	1		
C4	Capacitor: fixed, ceramic, 0.02 μ f \pm 10%, 600 vdcw	91418	0150-0024	2	1		
C5	Same as C3						
C6	Capacitor: fixed, mica, 27 pf \pm 5%, 300 vdcw	00853	0140-0042	1	1		
C7	Capacitor: fixed, mica, 100 pf \pm 10%, 300 vdcw	76433	0140-0041	1	1		
C8	Capacitor: fixed, electrolytic, 2000 μ f, 6 vdcw	14655	0180-0002	1	1		
C9	Capacitor: fixed, electrolytic, 500 μ f, 15 vdcw	37942	0180-0001	1	1		
C10	Capacitor: fixed, electrolytic, 50 μ f, tol. +20% -10%, 50 vdcw	37942	0180-0029	1	1		
C11	Capacitor: fixed, mica, 68 pf \pm 10%, 500 vdcw	00853	0140-0025	1	1		
C12	Capacitor: fixed, mica, 100 pf \pm 10%, 500 vdcw	00853	0140-0054	1	1		
C13	Capacitor: fixed, mica, 56 pf \pm 10%, 500 vdcw	76433	0140-0014	1	1		
C14	Capacitor: fixed, mylar, 0.82 μ f \pm 10%, 400 vdcw	72928	0160-0004	1	1		
C15	Capacitor: fixed, paper, 0.27 μ f, tol. -15% +20%, 600 vdcw	00853	0160-0041	1	1		
C16	Capacitor: fixed, paper, 0.082 μ f \pm 10%, 600 vdcw	56289	0160-0032	1	1		
C17	Capacitor: fixed, paper, 0.027 μ f \pm 10%, 600 vdcw	56289	0160-0026	1	1		
C18	Capacitor: fixed, paper, 0.0082 μ f \pm 10%, 600 vdcw	56289	0160-0011	1	1		
C19	Capacitor: fixed, paper, 0.0027 μ f \pm 10%, 600 vdcw	56289	0160-0044	1	1		

* Refer to "List of Manufacturers' Codes".

TQ Total Quantity used in the instrument.

RS Recommended spares for one year isolated service for one instrument.

TABLE OF REPLACEABLE PARTS

Circuit Ref.	Description	Mfr. *	^{hp} Stock No.	TQ	RS		
C20	Capacitor: fixed, silver mica, 820 pf $\pm 5\%$, 500 vdcw	00853	0140-0091	1	1		
C21	Capacitor: fixed, silver mica, 240 pf $\pm 5\%$, 500 vdcw	00853	0140-0092	1	1		
C22	Capacitor: fixed, mica, 75 pf $\pm 5\%$, 300 vdcw	76433	0140-0040	1	1		
C23	Capacitor: fixed, paper, 0.1 μ f $\pm 10\%$, 600 vdcw	56289	0160-0001	1	1		
C24, 25	Capacitor: fixed, paper, 0.1 μ f $\pm 10\%$, 400 vdcw	56289	0160-0013	2	1		
C26, 27	Capacitor: fixed, electrolytic, 40 μ f, 450 vdcw	56289	0180-0024	2	1		
C28	Capacitor: fixed, mylar, .22 μ f $\pm 10\%$, 200 vdcw	56289	0170-0038	1	1		
C29	Capacitor: fixed, mylar, 0.1 μ f $\pm 20\%$, 600 vdcw	28480	0170-0022	1	1		
C30	Capacitor: fixed, electrolytic, 20 μ f, 50 vdcw	14655	0180-0026	1	1		
C31	Capacitor: fixed, electrolytic, 10 μ f $\pm 50\%$, 450 vdcw	37942	0180-0005	1	1		
C32	Same as C4						
DS1	Lamp, incandescent: 6-8V, .15 amp, #47	24455	2140-0009	1	1		
F1	Fuse, cartridge: 1.6 amp, slow-blow for 115V operation	71400	2110-0005	1	10		
	Fuse, cartridge: .8 amp, slow-blow for 230V operation	75915	2110-0020				
I1	Lamp, glow: 1/25 W	24455	2140-0008	2	2		
I2, 3	Not assigned						
I4	Same as I1						
J1	Jack, telephone: (phototube)	82389	1251-0072	1	1		
J2	Connector, female, BNC (input)	91737	1250-0001	2	1		
J3	Jack, telephone (recorder)	82389	1251-0068	1	1		
J4	Same as J2 (pulse)						

* Refer to "List of Manufacturers' Codes".

TQ Total Quantity used in the instrument.

RS Recommended spares for one year isolated service for one instrument.

TABLE OF REPLACEABLE PARTS

Circuit Ref.	Description	Mfr. *	 Stock No.	TQ	RS		
M1	Meter, for 500B	65092	1120-0052	1	1		
	or Meter, for 500C	65092	1120-0053	1	1		
P1	Cable, power	70903	812-56	1	1		
R1	Resistor: variable, composition, 1 megohm $\pm 30\%$, include S3	71590	2100-0132	1	1		
R2	Resistor: fixed, composition, 22,000 ohms $\pm 10\%$, 1 W	01121	0690-2231	2	1		
R3	Resistor: fixed, composition, 10,000 ohms $\pm 10\%$, 1/2 W	01121	0687-1031	2	1		
R4	Resistor: fixed, composition, 2.2 megohms $\pm 10\%$, 1/2 W	01121	0687-2251	1	1		
R5	Not assigned						
R6	Resistor: fixed, composition, 33,000 ohms $\pm 10\%$, 1 W	01121	0690-3331	1	1		
R7	Same as R2						
R8	Resistor: fixed, composition, 3.9 megohms $\pm 10\%$, 1/2 W	01121	0687-3951	1	1		
R9	Resistor: fixed, composition, 22,000 ohms $\pm 10\%$, 1/2 W	01121	0687-2231	1	1		
R10	Not assigned						
R11	Resistor: fixed, deposited carbon, 1.5 megohms $\pm 1\%$, 1/2 W	19701	0727-0282	1	1		
R12	Resistor: variable, composition, linear taper, 500,000 ohms $\pm 30\%$, 1/4 W	71450	2100-0102	2	1		
R13	Resistor: fixed, deposited carbon, 1.2 megohms $\pm 1\%$, 1/2 W	75042	0727-0280	1	1		
R14	Resistor: fixed, composition, 100 ohms $\pm 10\%$, 1/2 W	01121	0687-1011	4	1		
R15	Resistor: fixed, composition, 2400 ohms $\pm 5\%$, 1 W	01121	0689-2425	1	1		
R16	Resistor: fixed, composition, 4700 ohms $\pm 10\%$, 2 W	01121	0693-4721	1	1		

* Refer to "List of Manufacturers' Codes".

TQ Total Quantity used in the instrument.

RS Recommended spares for one year isolated service for one instrument.

TABLE OF REPLACEABLE PARTS

Circuit Ref.	Description	Mfr. *	^{hp} Stock No.	TQ	RS		
R17	Resistor: fixed, glass body, 15,000 ohms $\pm 5\%$, 4 W	07115	0770-0006	1	1		
R18, 19	Resistor: fixed, composition, 82,000 ohms $\pm 10\%$, 1 W	01121	0690-8231	3	1		
R20	Resistor: fixed, composition, 8200 ohms $\pm 10\%$, 1/2 W	01121	0687-8211	1	1		
R21	Same as R14						
R22, 23	Not assigned						
R24, 25	Resistor: variable, dual, front sect. 3100 ohms rear sect. 100 ohms	71450	2100-0081	2	1		
R26	Resistor: fixed, wirewound, 3000 ohms $\pm 5\%$, 1 W	75042	0812-0010	1	1		
R27	Same as R3						
R28	Resistor: variable, wirewound, 50 ohms	42190	2100-0020	1	1		
R29	Resistor: variable, wirewound, 100 ohms	42190	2100-0021	1	1		
R30	Resistor: fixed, wirewound, 550 ohms $\pm 15\%$	28480	500B-26B	1	1		
R31	Resistor: variable, wirewound, 30 ohms	42190	2100-0032	1	1		
R32	Resistor: fixed, wirewound, 115 ohms $\pm 1\%$	28480	500B-26A	1	1		
R33	Resistor: fixed, composition, 3300 ohms $\pm 10\%$, 2 W	01121	0693-3321	1	1		
R34	Resistor: fixed, metal film, 5000 ohms $\pm 10\%$, 4 W	07115	0771-0003	1	1		
R35	Resistor: variable, composition, linear taper, 500 ohms $\pm 10\%$	12697	2100-0019	2	1		
R36	Resistor: fixed, composition, 1500 ohms $\pm 10\%$, 2 W	01121	0693-1521	1	1		
R37	Resistor: fixed, composition, 18,000 ohms $\pm 10\%$, 1 W	01121	0690-1831	1	1		
R38	Resistor: fixed, wirewound, 1600 ohms $\pm 10\%$, 1 W	75042	0812-0004	1	1		

* Refer to "List of Manufacturers' Codes".

TQ Total Quantity used in the instrument.

RS Recommended spares for one year isolated service for one instrument.

TABLE OF REPLACEABLE PARTS

Circuit Ref.	Description	Mfr. *	^{hp} Stock No.	TQ	RS		
R39	Same as R35						
R40	Same as R14						
R41	Resistor: fixed, composition, 47,000 ohms $\pm 10\%$, 1 W	01121	0690-4731	2	1		
R42	Same as R18						
R43	Resistor: fixed, metal film, 24,000 ohms $\pm 10\%$, 4 W	07115	0771-0005	1	1		
R44	Resistor: fixed, composition, 27,000 ohms $\pm 10\%$, 1 W	01121	0690-2731	1	1		
R45	Resistor: variable, composition, linear taper, 20,000 ohms $\pm 20\%$, 1/4 W	71450	2100-0093	1	1		
R46	Resistor: fixed, composition, 68,000 ohms $\pm 10\%$, 1 W	01121	0690-6831	1	1		
R47 thru R55	Range resistors Optimum value selected at factory Average value shown						
R56	Resistor: fixed, composition, 150,000 ohms $\pm 10\%$, 1 W	01121	0690-1541	2	1		
R57	Resistor: variable, composition, 25,000 ohms $\pm 20\%$, 1/3 W	71450	2100-0009	1	1		
R58	Resistor: fixed, deposited carbon, 144,000 ohms $\pm 1\%$, 1 W Optimum value selected at factory Average value shown	19701	0730-0074	1	1		
R59	Same as R14						
R60	Resistor: fixed, metal film, 30,000 ohms $\pm 1\%$, 2 W	07115	0771-0007	1	1		
R61	Resistor: fixed, composition, 100,000 ohms $\pm 10\%$, 1 W	01121	0690-1041	3	1		
R62	Resistor: fixed, composition, 390,000 ohms $\pm 10\%$, 1 W	01121	0690-3941	1	1		
R63	Same as R56						
R64	Resistor: fixed, composition, 220,000 ohms $\pm 10\%$, 1/2 W	01121	0687-2241	1	1		
R65	Resistor: fixed, composition, 470,000 ohms $\pm 10\%$, 1/2 W	01121	0687-4741	2	1		

* Refer to "List of Manufacturers' Codes".
TQ Total Quantity used in the instrument.
RS Recommended spares for one year isolated service for one instrument.

TABLE OF REPLACEABLE PARTS

Circuit Ref.	Description	Mfr. *	Ⓟ Stock No.	TQ	RS		
R66	Resistor: fixed, composition, 1.2 megohms ±10%, 1/2 W	01121	0687-1251	1	1		
R67	Resistor: fixed, composition, 4.7 megohms ±10%, 1/2 W	01121	0687-4751	1	1		
R68, 69	Same as R61						
R70	Resistor: fixed, composition, 150,000 ohms ±10%, 1/2 W	01121	0687-1541	1	1		
R71	Resistor: fixed, composition, 39,000 ohms ±10%, 1/2 W	01121	0687-3931	1	1		
R72, 73	Resistor: fixed, wirewound, 3000 ohms ±10%, 10 W	35434	0816-0002	1	1		
R74	Resistor: fixed, composition, 680 ohms ±10%, 1/2 W	01121	0687-6811	1	1		
R75	Same as R65						
R76	Resistor: fixed, composition, 27 ohms ±10%, 1/2 W	01121	0687-2701	1	1		
R77	Same as R4						
R78	Same as R12						
R79	Resistor: fixed, composition, 1 megohm ±10%, 1/2 W	01121	0687-1051	1	1		
R80	Resistor: fixed, composition, 22,000 ohms ±10%, 2 W	01121	0693-2231	1	1		
R81	Resistor: fixed, composition, 18,000 ohms ±10%, 2 W	01121	0693-1831	1	1		
R82	Resistor: fixed, composition, 3300 ohms ±10%, 1 W	01121	0690-3321	1	1		
R83	Resistor: fixed, composition, 33 ohms ±10%, 1 W	01121	0690-3301	1	1		
R84	Resistor: fixed, composition, 220,000 ohms ±10%, 1/2 W	01121	0687-2241	1	1		
R85	Resistor: fixed, composition, 470 ohms ±10%, 1 W	01121	0690-4711	1	1		
R86 thru R102	Resistor: fixed, composition, 1800 ohms ±10%, 1/2 W	01121	0687-1821	16	4		
R103, 104	Resistor: fixed, composition, 1500 ohms ±10%, 1/2 W	01121	0687-1521	2	1		

* Refer to "List of Manufacturers' Codes".
 TQ Total Quantity used in the instrument.
 RS Recommended spares for one year isolated service for one instrument.

TABLE OF REPLACEABLE PARTS

Circuit Ref.	Description	Mfr. *	Ⓟ Stock No.	TQ	RS		
R105	Resistor: fixed, composition, 330,000 ohms $\pm 10\%$, 1/2 W	01121	0687-3341	1	1		
R106	Resistor: fixed, wirewound, 104 ohms	28480	430B-26E	1	1		
R107	Same as R41 Optimum value selected at factory Average value shown Part may be omitted						
S1	Range Switch Assembly: complete	28480	500B-19WA	1	1		
S2	Switch, lever	71590	3100-0144	1	1		
S3	Part of R1						
S4	Switch, toggle: SPST	04009	3101-0001	1	1		
T1	Transformer, power	96501	9100-0018	1	1		
V1	Tube, electron: 12AT7	80131	1932-0027	1	1		
V2	Tube, electron: 5965	80131	1932-0009	2	2		
V3	Tube, electron: 6AL5	80131	1930-0013	3	3		
V4	Tube, electron: 6350	80131	1932-0013	1	1		
V5	Tube, electron: 5725	80131	1923-0002	1	1		
V6	Same as V2						
V7	Same as V3						
V8	Tube, electron: 5Y3GT	80131	1930-0010	1	1		
V9	Same as V3						
V10	Tube, electron: 6AU5	80131	1923-0020	1	1		
V11	Tube, electron: 6CB6	80131	1923-0028	1	1		
V12	Tube, electron: OB2	80131	1940-0007	1	1		
	<u>MISCELLANEOUS</u>						
	Accessory meter for 500B	28480	500B-95A	1	0		
	Accessory meter for 500C	28480	500C-95A	1	0		
	Fuseholder	75915	1400-0087	1	1		
	Knob Assembly: (range switch)	28480	500B-40A	1	0		
	Knob: lever	28480	G-74AA	1	0		
	Knob: OFFSET (skirted, w/arrow)	28480	G-74L	1	0		
	Knob: OFFSET	28480	G-74A	1	0		
	Knob: SENSITIVITY	28480	G-74G	1	0		

* Refer to "List of Manufacturers' Codes".

TQ Total Quantity used in the instrument.

RS Recommended spares for one year isolated service for one instrument.

APPENDIX CODE LIST OF MANUFACTURERS (Sheet 1 of 2)

The following code numbers are from the Federal Supply Code for Manufacturers Cataloging Handbooks H4-1 (Name to Code) and H4-2 (Code to Name) and their latest supplements. The date of revision and the date of the supplements used appear at the bottom of each page. Alphabetical codes have been arbitrarily assigned to suppliers not appearing in the H4 handbooks.

CODE NO.	MANUFACTURER	ADDRESS	CODE NO.	MANUFACTURER	ADDRESS	CODE NO.	MANUFACTURER	ADDRESS
00334	Humidial Co.	Colton, Calif.	16758	Delco Radio Div. of G. M. Corp.	Kokomo, Ind.	71744	Chicago Miniature Lamp Works	Chicago, Ill.
00335	Westrex Corp.	New York, N.Y.	18873	E. I. DuPont and Co., Inc.	Wilmington, Del.	71753	A. O. Smith Corp., Crowley Div.	West Orange, N.J.
00373	Garlock Packing Co., Electronic Products Div.	Camden, N.J.	19315	Eclipse Pioneer, Div. of Bendix Aviation Corp.	Teterboro, N.J.	71785	Cinch Mfg. Corp.	Chicago, Ill.
00656	Aerovox Corp.	New Bedford, Mass.	19500	Thomas A. Edison Industries, Div. of McGraw-Edison Co.	West Orange, N.J.	71984	Dow Corning Corp.	Midland, Mich.
00781	Aircraft Radio Corp.	Boonton, N.J.	24446	General Electric Co.	Schenectady, N.Y.	72136	Electro Motive Mfg. Co., Inc.	Willimantic, Conn.
00853	Sangamo Electric Co., Cap. Div.	Marion, Ill.	24455	G. E., Lamp Division	Nela Park, Cleveland, Ohio	72619	Dialight Corp.	Brooklyn, N.Y.
00866	Goe Engineering Co.	Los Angeles, Calif.	24655	General Radio Co.	West Concord, Mass.	72656	General Ceramics Corp.	Keasbey, N.J.
00891	Carl E. Holmes Corp.	Los Angeles, Calif.	26992	Hamilton Watch Co.	Lancaster, Pa.	72758	Girard-Hopkins	Oakland, Calif.
01121	Allen Bradley Co.	Milwaukee, Wis.	28480	Hewlett-Packard Co.	Palo Alto, Calif.	72765	Drake Mfg. Co.	Chicago, Ill.
01255	Litton Industries, Inc.	Beverly Hills, Calif.	33173	G. E. Receiving Tube Dept.	Owensboro, Ky.	72825	Hugh H. Eby Inc.	Philadelphia, Pa.
01281	Pacific Semiconductors, Inc.	Culver City, Calif.	35434	Lectrohm Inc.	Chicago, Ill.	72928	Gudeman Co.	Chicago, Ill.
01295	Texas Instruments, Inc. Semiconductor Components Div.	Dallas, Texas	37942	P. R. Mallory & Co., Inc.	Indianapolis, Ind.	72982	Erie Resistor Corp.	Erie, Pa.
01349	The Alliance Mfg. Co.	Alliance, Ohio	39543	Mechanical Industries Prod. Co.	Akron, Ohio	73061	Hansen Mfg. Co., Inc.	Princeton, Ind.
01561	Chassi-Trak Corp.	Indianapolis, Ind.	40920	Miniature Precision Bearings, Inc.	Keene, N.H.	73138	Heliport Div. of Beckman Instruments, Inc.	Fullerton, Calif.
02114	Ferroxcube Corp. of America	Saugerties, N.Y.	42190	Muter Co.	Chicago, Ill.	73293	Hughes Products Div. of Hughes Aircraft Co.	Newport Beach, Calif.
02286	Cole Mfg. Co.	Palo Alto, Calif.	44655	Ohmite Mfg. Co.	Skokie, Ill.	73445	Amperex Electronic Co., Div. of North American Phillips Co., Inc.	Hicksville, N.Y.
02660	Amphenol Electronics Corp.	Chicago, Ill.	48620	Precision Thermometer and Inst. Co.	Philadelphia, Pa.	73506	Bradley Semiconductor Corp.	New Haven, Conn.
02735	Radio Corp. of America Semiconductor and Materials Div.	Somerville, N.J.	49956	Raytheon Mfg. Co.	Waltham, Mass.	73559	Carling Electric, Inc.	Hartford, Conn.
02777	Hopkins Engineering Co.	San Fernando, Calif.	54294	Shallcross Mfg. Co.	Selma, N.C.	73682	George K. Garrett Co., Inc.	Philadelphia, Pa.
03508	G.E. Semiconductor Products Dept.	Syracuse, N.Y.	55026	Simpson Electric Co.	Chicago, Ill.	73743	Fischer Special Mfg. Co.	Cincinnati, Ohio
03705	Apex Machine & Tool Co.	Dayton, Ohio	55933	Sonotone Corp.	Elmsford, N.Y.	73793	The General Industries Co.	Elyria, Ohio
03797	Eldema Corp.	El Monte, Calif.	55938	Sorenson & Co., Inc.	So. Norwalk, Conn.	73905	Jennings Radio Mfg. Co.	San Jose, Calif.
04009	Arrow, Hart and Hegeman Elect. Co.	Hartford, Conn.	56137	Spaulding Fibre Co., Inc.	Tonawanda, N.Y.	74455	J. H. Winns, and Sons	Winchester, Mass.
04062	Elmenco Products Co.	New York, N.Y.	56289	Sprague Electric Co.	North Adams, Mass.	74861	Industrial Condenser Corp.	Chicago, Ill.
04222	Hi-Q Division of Aerovox	Myrtle Beach, S.C.	61775	Union Switch and Signal, Div. of Westinghouse Air Brake Co.	Pittsburgh, Pa.	74868	Industrial Products Co.	Danbury, Conn.
04404	Dymec Inc.	Palo Alto, Calif.	62119	Universal Electric Co.	Owosso, Mich.	74970	E. F. Johnson Co.	Waseca, Minn.
04651	Special Tube Operations of Sylvania Electronic Systems	Mountain View, Calif.	64959	Western Electric Co., Inc.	New York, N.Y.	75042	International Resistance Co.	Philadelphia, Pa.
04713	Motorola, Inc., Semiconductor Prod. Div.	Phoenix, Arizona	65092	Weston Inst. Div. of Daystrom, Inc.	Newark, N.J.	75173	Jones, Howard B., Division of Cinch Mfg. Corp.	Chicago, Ill.
04777	Automatic Electric Sales Corp.	Northlake, Ill.	70119	Advance Electric and Relay Co.	Burbank, Calif.	75378	James Knights Co.	Sandwich, Ill.
05624	Barber Colman Co.	Rockford, Ill.	70276	Allen Mfg. Co.	Hartford, Conn.	75382	Kulka Electric Mfg. Co., Inc.	Mt. Vernon, N.Y.
05783	Stewart Engineering Co.	Soquel, Calif.	70309	Allied Control Co., Inc.	New York, N.Y.	75818	Lenz Electric Mfg. Co.	Chicago, Ill.
06004	The Bassick Co.	Bridgeport, Conn.	70563	Amperite Co., Inc.	New York, N.Y.	75915	Littelfuse Inc.	Des Plaines, Ill.
06812	Torrington Mfg. Co., West. Div.	Van Nuys, Calif.	70903	Belden Mfg. Co.	Chicago, Ill.	76005	Lord Mfg. Co.	Erie, Pa.
07115	Corning Glass Works Electronic Components Dept.	Bradford, Pa.	70998	Bird Electronic Corp.	Cleveland, Ohio	76210	C. W. Marwedel	San Francisco, Calif.
07261	Avnet Corp.	Los Angeles, Calif.	71002	Birnbach Radio Co.	New York, N.Y.	76433	Micamold Electronic Mfg. Corp.	Brooklyn, N.Y.
07263	Fairchild Semiconductor Corp.	Mountain View, Calif.	71218	Bud Radio Inc.	Cleveland, Ohio	76487	James Millen Mfg. Co., Inc.	Malden, Mass.
07933	Rheem Semiconductor Corp.	Mountain View, Calif.	71286	Camloc Fastener Corp.	Paramus, N.J.	76530	Monadnock Mills	San Leandro, Calif.
07980	Boonton Radio Corp.	Boonton, N.J.	71313	Allen D. Cardwell Electronic Prod. Corp.	Plainville, Conn.	76545	Mueller Electric Co.	Cleveland, Ohio
08718	Cannon Electric Co. Phoenix Div.	Phoenix, Ariz.	71400	Bussmann Fuse Div. of McGraw- Edison Co.	St. Louis, Mo.	76854	Oak Manufacturing Co.	Chicago, Ill.
08733	Camloc Fastener Corp.	Los Angeles, Calif.	71450	Chicago Telephone Supply Co.	Elkhart, Ind.	77068	Bendix Corp., Bendix Pacific Div.	No. Hollywood, Calif.
08792	CBS Electronics Semiconductor Operations, Div. of C.B.S. Inc.	Lowell, Mass.	71468	Cannon Electric Co.	Los Angeles, Calif.	77221	Phaoston Instrument and Electronic Co.	South Pasadena, Calif.
09134	Texas Capacitor Co.	Houston, Texas	71471	Cinema Engineering Co.	Burbank, Calif.	77342	Potter and Brumfield, Inc.	Princeton, Ind.
09250	Electro Assemblies, Inc.	Chicago, Ill.	71482	C. P. Clare & Co.	Chicago, Ill.	77630	Radio Condenser Co.	Camden, N.J.
10646	Carborundum Co.	Niagara Falls, N.Y.	71590	Centralab Div. of Globe Union Inc.	Milwaukee, Wis.	77634	Radio Essentials Inc.	Mt. Vernon, N.Y.
12697	Clarostat Mfg. Co.	Dover, N.H.	71700	The Cornish Wire Co.	New York, N.Y.	77638	Radio Receptor Co., Inc.	Brooklyn, N.Y.
14655	Cornell Dubilier Elec. Corp.	So. Plainfield, N.J.				77764	Resistance Products Co.	Harrisburg, Pa.
15909	The Daven Co.	Livingston, N.J.				78283	Signal Indicator Corp.	New York, N.Y.

From: F.S.C. Handbook Supplements
H4-1 Dated July 1960
H4-2 Dated July 1960

APPENDIX CODE LIST OF MANUFACTURERS (Sheet 2 of 2)

CODE NO.	MANUFACTURER	ADDRESS	CODE NO.	MANUFACTURER	ADDRESS	CODE NO.	MANUFACTURER	ADDRESS
80131	Electronic Industries Association Any brand tube meeting EIA standards	Washington, D.C.	89473	General Electric Distributing Corp.	Schenectady, N.Y.	98405	Carad Corp.	Redwood City, Calif.
80248	Oxford Electric Corp.	Chicago, Ill.	90179	U.S. Rubber Co., Mechanical Goods Div.	Passaic, N.J.	98734	Palo Alto Engineering Co., Inc.	Palo Alto, Calif.
80411	Acro Manufacturing Co.	Columbus, Ohio	90970	Bearing Engineering Co.	San Francisco, Calif.	98925	Clevite Transistor Prod. Div. of Clevite Corp.	Waltham, Mass.
80486	All Star Products Inc.	Defiance, Ohio	91418	Radio Materials Co.	Chicago, Ill.	99109	Columbia Technical Corp.	New York, N.Y.
80583	Hammerlund Co., Inc.	New York, N.Y.	91506	Augat Brothers, Inc.	Attleboro, Mass.	99313	Varian Associates	Palo Alto, Calif.
80640	Stevens, Arnold, Co., Inc.	Boston, Mass.	91637	Dale Products, Inc.	Columbus, Neb.	99800	Delevan Electronics Corp.	East Aurora, N.Y.
81030	International Instruments, Inc.	New Haven, Conn.	91662	Elco Corp.	Philadelphia, Pa.	99821	North Hills Electric Co.	Great Neck, L.I., N.Y.
81415	Wilkor Products, Inc.	Cleveland, Ohio	91737	Gremer Mfg. Co., Inc.	Wakefield, Mass.	99848	Wilco Corporation	Indianapolis, Ind.
81453	Raytheon Mfg. Co., Industrial Tube Division	Quincy, Mass.	91929	Micro-Switch Div. of Minneapolis Honeywell Regulator Co.	Freeport, Ill.	99934	Renbrandt, Inc.	Boston, Mass.
81483	International Rectifier Corp.	El Segundo, Calif.	92196	Universal Metal Products, Inc.	Bassett Puente, Calif.	99942	Hoffman Semiconductor Div. of Hoffman Electronics, Corp.	Evanston, Ill.
82042	Carter Parts Co.	Skokie, Ill.	93332	Sylvania Electric Prod. Inc., Semiconductor Div.	Woburn, Mass.	99957	Technology Instruments Corp. of Calif.	No. Hollywood, Calif.
82170	Allen B. DuMont Labs., Inc.	Clifton, N.J.	93410	Stevens Mfg. Co., Inc.	Mansfield, Ohio	THE FOLLOWING H-P VENDORS HAVE NO NUMBER ASSIGNED IN THE LATEST SUPPLEMENT TO THE FEDERAL SUPPLY CODE FOR MANUFACTURERS HANDBOOK. 0000A Amp, Inc. Hawthorne, Calif. 0000B Chicago Telephone of Calif. S. Pasadena, Calif. 0000C Connor Spring Mfg. Co. San Francisco, Calif. 0000D Connex Corp. Oakland, Calif. 0000E Fisher Switches, Inc. San Francisco, Calif. 0000F Malco Tool and Die Los Angeles, Calif. 0000G Microwave Engineering Co. Palo Alto, Calif. 0000H Philco Corp. (Lansdale Tube Division) Lansdale, Pa. 0000I Telefunken (c/o American Elite) New York, N.Y. 0000J Ti Tal, Inc. Berkeley, Calif. 0000K Transatron Electronic Sales Corp. Wakefield, Mass. 0000L Winchester Electronics, Inc. Santa Monica, Calif. 0000M Western Coil Div. of Automatic Ind., Inc. Redwood City, Calif. 0000N Nahm-Bros. Spring Co. San Leandro, Calif. 0000P Ty-Car Mfg. Co., Inc. Holliston, Mass. 0000R Metro Cap. Div., Metropolitan Telecommunications Corp. Brooklyn, N.Y.		
82209	Maguire Industries, Inc.	Greenwich, Conn.	93983	Insuline-Van Norman Ind., Inc. Electronic Division	Manchester, N.H.			
82219	Sylvania Electric Prod. Inc., Electronic Tube Div.	Emporium, Pa.	94144	Raytheon Mfg. Co., Receiving Tube Div.	Quincy, Mass.			
82376	Astron Co.	East Newark, N.J.	94145	Raytheon Mfg. Co., Semiconductor Div.	Newton, Mass.			
82389	Switchcraft, Inc.	Chicago, Ill.	94154	Tung-Sol Electric, Inc.	Newark, N.J.			
82647	Spencer Thermostat, Div. of Texas Instruments, Inc.	Attleboro, Mass.	94197	Curtiss-Wright Corp., Electronics Div.	Carlstadt, N.J.			
82866	Research Products Corp.	Madison, Wis.	94310	Tru Ohm Prod. Div. of Model Engineering and Mfg. Co.	Chicago, Ill.			
82893	Vector Electronic Co.	Glendale, Calif.	95236	Allies Products Corp.	Miami, Fla.			
83148	Electro Cords Co.	Los Angeles, Calif.	95238	Continental Connector Corp.	Woodside, N.Y.			
83186	Victory Engineering Corp.	Union, N.J.	95263	Leecraft Mfg. Co., Inc.	New York, N.Y.			
83298	Bendix Corp., Red Bank Div.	Red Bank, N.J.	95265	National Coil Co.	Sheridan, Wyo.			
83594	Burroughs Corp., Electronic Tube Div.	Plainfield, N.J.	95987	Weckesser Co.	Chicago, Ill.			
83777	Model Eng. and Mfg., Inc.	Huntington, Ind.	96067	Huggins Laboratories	Sunnyvale, Calif.			
83821	Loyd Scruggs Co.	Festus, Mo.	96095	Hi-Q Division of Aerovox	Olean, N.Y.			
84171	Arco Electronics, Inc.	New York, N.Y.	96296	Solar Manufacturing Co.	Los Angeles, Calif.			
84396	A. J. Glesener Co., Inc.	San Francisco, Calif.	96341	Microwave Associates, Inc.	Burlington, Mass.			
84411	Good All Electric Mfg. Co.	Ogallala, Neb.	96501	Excel Transformer Co.	Oakland, Calif.			
84970	Sarkes Tarzian, Inc.	Bloomington, Ind.	97539	Automatic and Precision Mfg. Co.	Yonkers, N.Y.			
85474	R. M. Bracamonte & Co.	San Francisco, Calif.	97966	CBS Electronics, Div. of C.B.S., Inc.	Danvers, Mass.			
85660	Koiled Kords, Inc.	New Haven, Conn.	98141	Axel Brothers Inc.	Jamaica, N.Y.			
86684	Radio Corp. of America, RCA Electron Tube Div.	Harrison, N.J.	98220	Francis L. Mosley	Pasadena, Calif.			
88140	Cutler-Hammer, Inc.	Lincoln, Ill.	98278	Microdot, Inc.	So. Pasadena, Calif.			
			98291	Sealectro Corp.	New Rochelle, N.Y.			

00015-2
Revised: 31 Jan. 1961

From: F.S.C. Handbook Supplements
H4-1 Dated July 1960
H4-2 Dated July 1960

CLAIM FOR DAMAGE IN SHIPMENT

The instrument should be tested as soon as it is received. If it fails to operate properly, or is damaged in any way, a claim should be filed with the carrier. A full report of the damage should be obtained by the claim agent, and this report should be forwarded to us. We will then advise you of the disposition to be made of the equipment and arrange for repair or replacement. Include model number and serial number when referring to this instrument for any reason.

WARRANTY

Hewlett-Packard Company warrants each instrument manufactured by them to be free from defects in material and workmanship. Our liability under this warranty is limited to servicing or adjusting any instrument returned to the factory for that purpose and to replace any defective parts thereof. Klystron tubes as well as other electron tubes, fuses and batteries are specifically excluded from any liability. This warranty is effective for one year after delivery to the original purchaser when the instrument is returned, transportation charges prepaid by the original purchaser, and when upon our examination it is disclosed to our satisfaction to be defective. If the fault has been caused by misuse or abnormal conditions of operation, repairs will be billed at cost. In this case, an estimate will be submitted before the work is started.

If any fault develops, the following steps should be taken:

1. Notify us, giving full details of the difficulty, and include the model number and serial number. On receipt of this information, we will give you service data or shipping instructions.

2. On receipt of shipping instructions, forward the instrument prepaid, to the factory or to the authorized repair station indicated on the instructions. If requested, an estimate of the charges will be made before the work begins provided the instrument is not covered by the warranty.

SHIPPING

All shipments of Hewlett-Packard instruments should be made via Truck or Railway Express. The instruments should be packed in a strong exterior container and surrounded by two or three inches of excelsior or similar shock-absorbing material.

DO NOT HESITATE TO CALL ON US

HEWLETT-PACKARD COMPANY

Laboratory Instruments for Speed and Accuracy

275 PAGE MILL ROAD

CABLE



PALO ALTO, CALIF. U.S.A.

"HEWPACK"



MANUAL CHANGES

MODEL 500B

ELECTRONIC FREQUENCY METER

MODEL 500C

ELECTRONIC TACHOMETER INDICATOR

Manual printed: 2-61

For Serials Prefixed: 015-

ERRATA in the Table of Replaceable Parts:

P1: Change -hp- Stock No. to read 8120-0050.

ERRATA in Table 2B-1,

Under "Line Voltage Variation From -10% to +10% During Measurement",

X3: Phantastron Timing Error should read 0.4.

10/5/61

3/2/61

